



Vehicle Services



irtools.com

If your tools aren't working, neither are you



For more than 100 years, professional technicians have relied on Ingersoll Rand for quality and performance on the toughest jobs. Our advanced engineering and manufacturing have set a standard of excellence often copied, but never matched. So, don't settle for less. Count on genuine Ingersoll Rand tools, accessories, and equipment.

You can depend on Ingersoll Rand

- Best-in-class power and durability
- Improved ease of use
- Reduced downtime
- World-wide service network

 **Ingersoll Rand**

MAXIMUM IMPACT



2135TiMAX

As if the Ingersoll Rand 2135Ti wasn't already the champion of the 1/2" air impact market, we decided to make it even better.

MAX Power

780 ft-lb maximum reverse torque and weighing just four pounds — the best power-to-weight ratio in its class

MAX Control

featherable trigger, wider range of power regulator settings, and patented one hand forward / reverse switch

MAX Reliability

rugged design backed by a new two-year limited warranty*

*Tool registration required

"I expect maximum performance from my crews. That's why they rely on Ingersoll Rand impacttools for every pit stop."

Ray Evernham,
Gillett Evernham Motorsports



For more information about the 2135TiMAX, talk to your tool professional or visit our Web site, irtools.com.



Contents



Air Impactools™ and Accessories 6

Ingersoll Rand air Impactools are the tools professional mechanics use when nothing else will do the job. They'll break loose a frozen bolt when others can't make it budge. With fewer working parts, simplified maintenance, and less wasted energy, Ingersoll Rand air Impactools are the finest examples of delivering more power to professional mechanics.



Sockets 17

Backed by an extensive heritage of reliability and innovation, Ingersoll Rand introduces a comprehensive line of industrial-grade sockets that really make an impact.



Air Ratchets and Accessories 42

Compact. Convenient. Real time-savers. Air ratchets have become essential elements in every serious toolbox. Ingersoll Rand ratchets combine access and power to make jobs more productive and profitable, and feature unique qualities you won't find anywhere else.



Air Cutting Tools, Grinders, and Accessories 46

With high-strength steels, advanced plastics, and new composite materials in today's cars and trucks, you need versatile tools for precise, controlled cutting. Ingersoll Rand cutting tools are the reliable choice of auto body and repair shops, used for everything from muffler and exhaust work to sunroof installations and body repairs.



Air Finishing Tools and Accessories 53

Ingersoll Rand has the most complete line of air finishing tools. Sanders, polishers, and buffers, from traditional styles for heavy material removal to the newest models for excellent control and brilliant surfaces. All Ingersoll Rand finishing tools are designed for long-life and swirl-free finishes.



Air Drills, Screwdrivers, and Accessories 59

Ingersoll Rand air drills have industrial-grade chucks and keyless chuck versions that are extra tough for drilling, sawing, valve guide reaming, cylinder honing, and wire brushing. They are powerful, efficient, and durable with smooth, quiet operation.



Air Hammers and Accessories 63

Our air hammers are designed so you can let the tool do the work, whether it's cutting, punching, chipping, or scraping. Each air hammer comes with a coil spring retainer for fast and easy chisel changes. You can also buy a five-piece chisel set, or get an Ingersoll Rand air hammer kit which includes both the hammer and the chisel set.

Mini Air Tools and Accessories 66

Ingersoll Rand offers a full line of mini air tools — the 2101K 1/4" mini impact kit, the 3103K mini surface prep grinder kit, the 3128K mini random orbital sander kit, the 3129K mini polisher kit, and the 7804K mini 1/4" drill / driver kit.



Cordless IQ^V™ Tools and Accessories..... 69

Ingersoll Rand IQ^V Series cordless tools are specifically designed for the service and production industries — delivering best-in-class power and durability, and a strong commitment to our customers. The same engineering that made our air tools the world's best now delivers cordless technologies that get the most out of every volt.



Air Compressors and System Components 82

For more than 75 years, Ingersoll Rand has been the world leader in air compressors and air system components. We understand rising energy costs and reduced margins require increased reliability and efficiency from not only your air compressor, but your entire air system. Simply stated, your air system is much more than an air compressor. It's the complete system — the piping, filters, dryers, drains, hoses, valves, and point-of-use tools.



Lubrication Equipment and Accessories 108

Ingersoll Rand lubrication equipment reflects the same high standards of performance as our tools and air compressors, with a full range of products that will keep all types of fluids moving efficiently. These products are the result of more than 70 years of experience in pump and air system technology, and include models specifically designed for popular applications.



Accessories 123

We offer an extensive line of accessories to match our tools with the requirements of every job. These accessories put the reliability and quality of Ingersoll Rand behind every job you do.



Pullers and Hoists 133

Ingersoll Rand pullers and hoists are designed to handle tough pulling or lifting jobs with minimal effort by the operator. Whether it's a low-, medium-, or heavy-duty job, you can trust our pullers and hoists to carry the load safely and easily.



See page 138 for complete Index

Air Impacttools™



There are good reasons why Ingersoll Rand pneumatic Impacttools are so highly regarded by professionals, especially in the automotive service industry. With decades of proven engineering expertise behind them, our Impacttools deliver rugged reliability and power in durable, compact packages. Ingersoll Rand pneumatic Impacttools offer the best power-to-weight ratios available on the market.



Model	Max Torque ft-lb (Nm)	Working Torque Range ft-lb (Nm)	Maximum Free Speed rpm	Weight lb (kg)	Length in (mm)	Average Air Consumption cfm (L/min)	Air Consumption @ Load cfm (L/min)	Sound Pressure / Power dBA	Air Inlet NPTF in	Min Hose Size in (mm)
1/4" MINI TOOL IMPACTTOOL KIT										
2101K	50 (68)	25 – 40 (34 – 54)	11,000	1.37 (0.62)	6.25"	1.76	18.17	83.6 / 94.6	1/4"	3/8" (10)
3/8" SQUARE DRIVE										
211*	150 (204)	20 – 125 (27 – 170)	10,000	2.40 (1.09)	6.6" (168)	2.5 (71)	11 (311)	104 / 117	1/4"	3/8" (10)
215*	160 (217)	15 – 130 (20 – 176)	9,500	2.89 (1.31)	6.125" (156)	3 (84)	13 (368)	87.5 / 100.5	1/4"	3/8" (10)
216	175 (237)	15 – 160 (20 – 217)	8,000	2.89 (1.31)	6.125" (156)	3 (84)	13 (368)	92.9 / 105.9	1/4"	3/8" (10)
212	180 (244)	20 – 150 (27 – 204)	10,000	2.89 (1.31)	6" (152)	2.5 (71)	11 (311)	97.5 / 110.5	1/4"	3/8" (10)
2115QTiMAX*	300 (407)	25 – 230 (34 – 312)	15,000	2.49 (1.13)	5.95" (151)	4 (113)	17 (481)	89.7 / 100.7	1/4"	3/8" (10)
2115TiMAX	300 (407)	25 – 230 (34 – 312)	15,000	2.48 (1.12)	5.95" (151)	4 (113)	17 (481)	96.6 / 107.6	1/4"	3/8" (10)

*Not pictured.

2101K

Mini 1/4" Impactool Kit

- Hard-hitting 5-vane motor delivers smooth and robust performance
- Easily accessible forward / reverse switch for one-handed operation
- Includes 10-piece 1/4" socket set



Fastens conveniently
in hard-to-reach
places

216

In-line Air Impactool

This durable in-line wrench is handy for the cramped spaces common to small engine repair and other general service work. The butterfly-style throttle valve lets you adjust speed smoothly in either direction in one continuous motion.

- Puts power and ergonomics in the palm of your hand
- Contoured composite butterfly throttle for comfort and control
- Recessed regulator dial



212

Air Impactool

Tremendous power and longer life make this wrench a popular choice of professional mechanics for exhaust systems, air conditioning, radiators, body shop, and bench work. The 212 offers all the advantages of the single-hammer impact mechanism for removing and replacing bolts up to 7/16" without a struggle.

- Power up to 180 ft-lb
- More torque, less vibration
- Built-in power regulator helps control torque



2115TiMAX

Air Impactool

The new 2115TiMAX delivers best in class performance for a tool less than six inches long and weighing less than two and a half pounds. The minimal size of this tool will allow greater access to tight spaces, while the minimal weight will reduce operator fatigue ... all while still delivering MAX performance.

- Best in class power performance
- Enhanced power settings
- Free two-year limited warranty with tool registration



Best power-to-weight
ratio in its class



1/2" Impacttools

Model	Max Torque ft-lb (Nm)	Working Torque Range ft-lb (Nm)	Maximum Free Speed rpm	Weight lb (kg)	Length in (mm)	Average Air Consumption cfm (L/min)	Air Consumption @ Load cfm (L/min)	Sound Pressure / Power dBA	Air Inlet NPTF in	Min Hose Size in (mm)
1/2" SQUARE DRIVE										
231C	600 (813)**	25 – 350 (34 – 475)	8,000	5.8 (2.63)	7.3" (185)	4.2 (119)	22 (623)	99 / 110	1/4"	3/8" (10)
236*	450 (610)	25 – 200 (34 – 271)	7,400	5.3 (2.4)	7.1" (180.3)	4.3 (122)	24 (680)	90.3 / 101.3	1/4"	3/8" (10)
244A	500 (678)	40 – 350 (54 – 475)	7,000	6 (2.72)	7.3" (185)	5.4 (153)	21 (595)	93 / 104	1/4"	3/8" (10)
244A-2*	500 (678)	40 – 350 (54 – 475)	7,000	6.3 (2.85)	9.5" (241)	5.4 (153)	21 (595)	93 / 104	1/4"	3/8" (10)
231HA*	590 (800)**	25 – 350 (34 – 475)	8,000	5.8 (2.63)	7.3" (185)	4.2 (119)	22 (623)	94 / 105	1/4"	3/8" (10)
231HA-2	590 (800)**	25 – 350 (34 – 475)	8,000	6.1 (2.76)	9.1" (236)	4.2 (119)	22 (623)	94 / 105	1/4"	3/8" (10)

*Not pictured.
**Reverse bias.

231C

Air Impactool

The classic 231C is the most popular tool in its class. Introduced over 25 years ago and continuously refined, it offers the sheer power and performance features to tackle the toughest jobs with ease — as well as proven durability and economy.

- Adjustable power regulator
- Pressure-fed lubrication
- Easy-to-service 2-piece construction



The most popular
Impactool in the world

244A

Air Impactool

Bring out the "big gun" for tire-changing, shock and spring work, front-end work, and other heavy automotive and truck work. The impact mechanism pumps out 500 ft-lb of torque at a free speed of 7,000 rpm to get the job done fast.

- Powerful with smooth, balanced blows
- Pressure-fed lubrication system automatically greases the impact mechanism
- Non-biased 500 ft-lb in forward and reverse



231HA-2

Extended Anvil Air Impactool

The 231HA-2 has set the standard for Impactool performance for over three decades. Refined engineering and design have perfected performance and made the 231HA-2 one of the most popular tire service Impactools ever. This elite mechanism is the perfect balance between superior power and proven durability.

- Pressure-fed lubrication system
- Handle exhaust directs air away from user
- Adjustable power regulation



Top choice in tire
service centers

Sockets

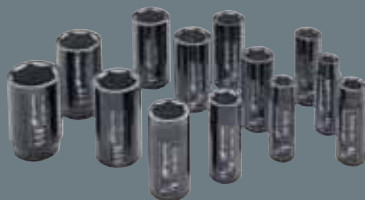

Genuine Ingersoll Rand Impact sockets are built with top-quality materials for performance and durability. For more information, turn to the sockets section — starting on page 17. See pages 14 – 16 for all other Impactool accessories.

Model	Max Torque ft-lb (Nm)	Working Torque Range ft-lb (Nm)	Maximum Free Speed rpm	Weight lb (kg)	Length in (mm)	Average Air Consumption cfm (L/min)	Air Consumption @ Load cfm (L/min)	Sound Pressure / Power dBA	Air Inlet NPTF in	Min Hose Size in (mm)
1/2" SQUARE DRIVE										
2125QTiMAX*	332 (450)**	25 – 251 (34 – 340)	15,000	2.51 (1.14)	6.1" (155)	4 (113)	17 (481)	89.7 / 100.7	1/4"	3/8" (10)
2130	550 (745)**	50 – 500 (68 – 680)	9,500	4.2 (1.9)	7.25" (184)	4.4 (124.6)	22 (623)	96.6 / 109.6	1/4"	3/8" (10)
2130-2*	550 (745)**	50 – 500 (68 – 680)	9,500	4.6 (2.05)	9.25" (235)	4.4 (124.6)	22 (623)	96.6 / 109.6	1/4"	3/8" (10)
232TGSL	625 (847)**	40 – 400 (54 – 544)	10,000	6 (2.72)	7.3" (185)	5.4 (153)	23 (651)	105 / 109.3	1/4"	3/8" (10)

*Not pictured.
**Reverse bias.

2130

Air Impactool

The 2130 has all the performance features you have come to expect from the Ingersoll Rand family of Impacttools. This Impacttool features a powerful twin-hammer mechanism and a composite housing, providing superior ergonomics in a lightweight package.

- 550 ft-lb maximum torque
- Full-stroke tease throttle
- Multi-position power management



Ingersoll Rand power and durability at an exceptional value

Model	Max Torque ft-lb (Nm)	Free Speed rpm	Weight lb (kg)	Length in (mm)	Voltage volts
8049 Model C	290 (393)	1,900	6.75 (3.1)	11-11/16" (297)	115

8049 Model C

Electric Impactool

Delivers maximum torque of 290 ft-lb. The unique reversing mechanism gives you full power in forward and reverse, making it an excellent choice for tire changing, shock absorber replacement, and exhaust system work.

- Up to 290 ft-lb torque
- Durable, made with ball and sleeve bearing construction
- Back-cap reverse switch allows full power in both directions



No longer URL certified.

232TGSL

ThunderGun® Street Legal™ Air Impactool

As close as you can get to the real racing tools used by 100 percent of NASCAR® pit crews. It features 625 ft-lb of torque in reverse, with 10,000 rpm to deliver pit crew power, speed, and durability.

- Our fastest 1/2" Impactool
- 10,000 rpm for lightning fast removal is best-in-class
- 625 ft-lb of torque



Impact Boots



Even the industry's hardest-working Impacttools could use added protection from the rigors of the jobsite. Our impact boots can be found on page 16. For a complete listing of Impacttool accessories, see pages 14 – 16.

1/2" Impactools

Model	Drive in	Max Torque (reverse) ft-lb (Nm)	Nut Busting Torque ft-lb (Nm)	Forward Torque Range ft-lb (Nm)	Blows per minute	Maximum Free Speed rpm	Sound Pressure / Power dBA	Net Weight lb (kg)	Overall Length in (mm)	Average Air Consumption cfm (L/min)	Air Inlet NPTF in	Min Hose Size in (mm)
1/2" SQUARE DRIVE												
2135TiMAX	1/2"	780 (1054)	1,100 (1486)	50 – 550 (68 – 746)	1,250	9,800	109	3.95 (1.79)	7.35 (186.7)	5 (142)	1/4"	3/8" (10)
2135Ti-2MAX*	1/2"	780 (1054)	1,100 (1486)	50 – 550 (68 – 746)	1,250	9,800	109	4.4 (1.99)	9.47 (240.5)	5 (142)	1/4"	3/8" (10)
2135QTiMAX	1/2"	780 (1054)	1,100 (1486)	50 – 550 (68 – 746)	1,250	9,800	86	4.05 (1.83)	7.35 (186.7)	5 (142)	1/4"	3/8" (10)
2135QTi-2MAX*	1/2"	780 (1054)	1,100 (1486)	50 – 550 (68 – 746)	1,250	9,800	86	4.5 (2.04)	9.47 (240.5)	5 (142)	1/4"	3/8" (10)

*Not pictured.
**Reverse bias.

2135TiMAX

Air Impact Wrench

The Titanium 2135TiMAX delivers 1,100 ft-lb of nut-busting torque in a gun that weighs just 3.95 lb. The 7-vane power plant drives enough torque to break away a nut tightened to over 1,100 ft-lb in under six seconds.

- Easy-to-use forward / reverse push buttons
- Professional touch trigger for precision control
- Power control dial



The best power-to-weight ratio in its class



Quiet Tools

All the power, without all the noise.

At Ingersoll Rand, we don't just stand behind our tools; we're equally devoted to the people who use them. We're constantly looking for ways to make your job easier.

With the innovative line of Quiet Tools from Ingersoll Rand, you get durable, reliable tools that deliver the power you need, but with less noise. Our patented Quiet Tool technology reduces the sound levels caused by air pulsating through the impact motor, without compromising our best-in-class torque levels.

Power and performance with less noise? Sure sounds good to us.

2135QTiMAX

Air Impact Wrench

Powerful and quiet. New technology developed by Ingersoll Rand has reset the standard for quiet technology coupled with raw power. The quiet version of our strongest 1/2" impact is perfect for high-volume tire shops and other applications involving frequent use.

- Patented technology silences the tool without sacrificing the power required for tough applications
- New ergonomically designed handle
- Titanium technology



Impactool Tune-up Kits



Extend the life of your tools. Even the most durable and reliable tools need preventive maintenance. Our Impactool tune-up kits and full line of Impactool accessories can be found on pages 14 – 16.

3/4" Impacttools

Model	Max Torque ft-lb (Nm)	Working Torque Range ft-lb (Nm)	Maximum Free Speed rpm	Weight lb (kg)	Length in (mm)	Average Air Consumption cfm (L/min)	Air Consumption @ Load cfm (L/min)	Sound Pressure / Power dBA	Air Inlet NPTF in	Min Hose Size in (mm)
3/4" SQUARE DRIVE										
252 *	750 (1020)	100 – 500 (136 – 680)	6,500	8.6 (3.9)	9" (229)	7.5 (212)	28 (793)	92.1 / 105.1	3/8"	1/2" (13)
258	1,000 (1360)	200 – 800 (272 – 1088)	6,200	10.77 (4.89)	9.8" (249)	8 (226)	30 (835)	93.7 / 106.7	3/8"	1/2" (13)
261	1,100 (1491)	200 – 900 (272 – 1224)	5,500	12.4 (5.62)	8.8" (224)	9.5 (269)	38 (1076)	98.1 / 109.1	3/8"	1/2" (13)
261-3*	1,100 (1491)	200 – 900 (272 – 1224)	5,500	13 (5.9)	11.8" (300)	9.5 (269)	38 (1076)	98.1 / 109.1	3/8"	1/2" (13)
261-6*	1,100 (1491)	200 – 900 (272 – 1224)	5,500	13.7 (6.21)	14.8" (376)	9.5 (269)	38 (1076)	98.1 / 109.1	3/8"	1/2" (13)
2141	1,200 (1627)	200 – 900 (272 – 1224)	8,000	7 (3.2)	8.2" (208)	9.5 (269)	40 (1133)	99.9 / 110.9	3/8"	1/2" (13)
2161XP	1,250 (1695)	300 – 1,000 (407 – 1356)	6,000	11.8 (5.35)	8.5" (216)	10 (283)	46 (1303)	98 / 111	3/8"	1/2" (13)
2161XP-6*	1,250 (1695)	300 – 1,000 (407 – 1356)	6,000	13.1 (5.95)	14.5" (368)	10 (283)	46 (1303)	98 / 111	3/8"	1/2" (13)

*Not pictured.

261

Air Impacttool

The highly regarded 261 model combines compact size at only 8.8" long with high output, which makes it perfect for everything from spring work to pinion nut and track pad removal and major engine teardowns.

- Jumbo hammer mechanism
- Up to 1,100 ft-lb of torque
- Pressure-fed lube system for trouble-free performance and longer life

For optional power regulator, please order part #2920-K329.



258

Air Impacttool

Delivers 1,000 ft-lb of maximum torque for work on trucks, heavy equipment, and agricultural machinery. Features an excellent power-to-weight ratio for ease of use, as well as a 3-speed power regulator for tailoring output in forward and reverse.

- Fully adjustable power in forward and reverse
- In-handle exhaust directs airflow away from the operator and the work
- 360° swivel inlet helps eliminate twisted hoses



2141

Air Impacttool

The 2141 delivers the best power-to-weight ratio and best size ratio in its class. The 2141 also provides great maneuverability for tight, awkward spaces.

- 1,200 ft-lb maximum torque
- Weighs just 7 lb
- Contoured professional touch trigger and ergonomically designed handle for increased comfort



The best power-to-weight ratio in its class

2161XP

Air Impacttool

The 2161XP combines a 6-vane, high-output air motor, through-bolt construction, ergonomic handle and housing design to create an Impacttool that offers increased power and durability.

- Most powerful 3/4" Impacttool in the industry
- Maximum torque of 1,250 ft-lb
- 3-position power regulator and 360° swivel inlet



Gloves



With the Ingersoll Rand line of industry-leading work gloves, you can pair our tough tools with gloves that offer the ultimate in protection, comfort, and performance. See page 125 for more information.

1" Impactools

Model	Max Torque ft-lb (Nm)	Working Torque Range ft-lb (Nm)	Maximum Free Speed rpm	Weight lb (kg)	Length in (mm)	Average Air Consumption cfm (L/min)	Air Consumption @ Load cfm (L/min)	Sound Pressure / Power dBA	Air Inlet NPTF in	Min Hose Size in (mm)
1" SQUARE DRIVE										
271	1,100 (1491)	200 – 900 (272 – 1224)	5,500	12.5 (5.67)	8.9" (226)	9.5 (269)	39 (1104)	98.1 / 109.1	3/8"	1/2" (13)
285B*	1,475 (2000)	100 – 900 (136 – 1220)	5,000	24.6 (11.16)	13.2" (335)	10 (283)	37 (1048)	103.4 / 114.4	1/2"	1/2" (13)
285B-6	1,475 (2000)	100 – 900 (136 – 1220)	5,000	27.8 (12.61)	20.1" (511)	10 (283)	37 (1048)	103.4 / 114.4	1/2"	1/2" (13)
280*	1,600 (2169)	150 – 1,000 (204 – 1360)	6,000	22 (9.98)	13" (330)	10 (283)	55 (1557)	109.1 / 122.1	1/2"	1/2" (13)
280-6	1,600 (2169)	150 – 1,000 (204 – 1360)	6,000	23.8 (10.80)	18.5" (470)	10 (283)	55 (1557)	109.1 / 122.1	1/2"	1/2" (13)
#5 SPLINE DRIVE										
285B-S6*	1,475 (2000)	100 – 900 (136 – 1220)	5,000	27.8 (12.61)	20.1" (511)	10 (283)	37 (1048)	103.4 / 114.4	1/2"	1/2" (13)
280-S-6*	1,600 (2169)	150 – 1,000 (204 – 1360)	6,000	23.8 (10.80)	18.5" (470)	10 (283)	55 (1557)	109.1 / 122.1	1/2"	1/2" (13)

*Not pictured.

271

Air Impactool

The shortest 1" air Impactool is also one of the most powerful. It combines a compact size with high power output, making it ideal for tire changing, spring work, pinion nut removal, tractor pad removal, and shock work.

- Impressive power-to-size ratio
- Up to 1,100 ft-lb of torque
- Pressure-fed lube system for longer service life



280-6

Air Impactool

High-production truck tire changing requires the brute force only this jumbo hammer impact mechanism delivers. Reach into deep truck wheels easily with this 6" extended anvil wrench, designed for high-production truck tire changing.

- 1,600 ft-lb of maximum torque
- Jumbo power mechanism for power and durability
- In-handle exhaust directs air away from user



285B-6

Air Impactool

The 285B models combine exceptional power, control and durability. They deliver 1,770 ft-lb of maximum torque @ 120 psi, with 5,250 rpm free speed and a high-efficiency, 6-vane motor. The swept-back 285B handle provides excellent maneuverability.

- Delivers 1,770 ft-lb maximum torque
- Fast-torque™ delivers 1,000 ft-lb in 2 seconds
- Improved feather touch trigger



Enhanced durability for longer life

Model	Max Torque ft-lb (Nm)	Working Torque Range ft-lb (Nm)	Maximum Free Speed rpm	Weight lb (kg)	Length in (mm)	Average Air Consumption cfm (L/min)	Air Consumption @ Load cfm (L/min)	Sound Pressure / Power dBA	Air Inlet NPTF in	Min Hose Size in (mm)
1" SQUARE DRIVE										
2171XP	1,250 (1695)	250 – 900 (407 – 1356)	6,000	13.1 (5.95)	12.5" (318)	10 (282)	46 (1303)	98 / 111	3/8"	1/2" (13)
295A	1,475 (2000)	100 – 900 (136 – 1220)	5,000	22.3 (10.12)	10.5" (267)	10 (283)	45 (1274)	101.1 / 112.1	1/2"	1/2" (13)
290	1,600 (2169)	150 – 1,000 (203 – 1356)	6,000	21.9 (9.93)	9.75" (248)	10 (283)	60 (1699)	104.6 / 117.6	1/2"	3/4" (19)
2190Ti*	1,650 (2237)	150 – 1,000 (203 – 1627)	6,800	14 (6.4)	15.38" (391)	12 (336)	58 (1642)	103.8 / 116.8	1/2"	1/2" (13)
2190Ti-6	1,650 (2237)	150 – 1,000 (203 – 1627)	6,800	15.5 (7.03)	21.48" (546)	12 (336)	58 (1642)	103.8 / 116.8	1/2"	1/2" (13)
2190DTi-6*	1,650 (2237)	150 – 1,000 (203 – 1627)	6,800	16 (7.3)	21.48" (546)	12 (336)	58 (1642)	103.8 / 116.8	3/8"	1/2" (13)
293*	2,000 (2712)	1,000 – 1,600 (1360 – 2176)	3,500	22.8 (10.34)	11.3" (287)	12 (340)	64 (1812)	90.3 / 103.3	1/2"	3/4" (19)
#5 SPLINE DRIVE										
290-S*	1,600 (2169)	150 – 1,000 (203 – 1356)	6,000	21.9 (9.93)	10" (254)	10 (283)	60 (1699)	104.6 / 117.6	1/2"	3/4" (19)
293-S*	2,000 (2712)	1,000 – 1,600 (1360 – 2176)	3,500	22.8 (10.34)	11.3" (287)	12 (340)	64 (1812)	90.3 / 103.3	1/2"	1/2" (13)

*Not pictured.

2171XP

Air Impactool

The 2171XP combines a 6-vane high output air motor, through-bolt construction, ergonomic handle and housing design to create an Impactool that offers increased power and durability.

- Maximum torque of 1,250 ft-lb
- 3-position power regulator
- 360° swivel inlet



290

Air Impactool

Designed for getting into cramped spaces with big power, the 290 has a 3-way adjustable handle. It's a good choice for spring work, tractor pads, bus maintenance, off-road equipment, and farm equipment.

- Up to 1,600 ft-lb of torque

For optional thread-on muffler, order part #2910-674.



2190Ti-6

Air Impactool

Designed specifically for high-volume fleet service, the revolutionary chainsaw-grip handle provides comfortable control to the operator. The 2190Ti-6 delivers an impressive 1,650 ft-lb of maximum torque in a lightweight package and comes standard with a 6" extended anvil.

- 1,650 ft-lb of maximum torque
- Weighs 15.5 lb
- Extended robust anvil bushing provides long life under heavy shop usage



295A

Air Impactool

The 295A model combines exceptional power, control, and durability. It delivers 1,770 ft-lb of maximum torque @ 120 psi (1,475 ft-lb @ 90 psi), with 5,250 rpm free speed and a high-efficiency, 6-vane motor. The top-mounted 295A dead handle provides great leverage for difficult underbody work.

- Delivers 1,770 ft-lb maximum torque
- Fast-torque™ delivers 1,000 ft-lb in 2 seconds
- Improved feather touch trigger
- Rubber boots protect tools from exterior damage



Impactool Hammer Kit



See pages 14 – 16 for our full line of Impactool accessories.

Impactool Tune-up Kits

Extend the life of your tools with genuine Ingersoll Rand repair kits and replacement parts. Every Ingersoll Rand part is specifically designed to enhance durability and improve the productivity of your tool.

Part Number	For Use With
3/8" IMPACTOOL TUNE-UP KITS	
215-THK1	215
211-TK2	211
212-TK2	212
215-TK1	215
216-TK1	216
2115-TK2	2115TiMAX Series
1/2" IMPACTOOL TUNE-UP KITS	
2130-TK1	2130, 2130-2
2135-TK2	2135 Series, 2135TiMAX Series
236-TK1	236
231HP-TK1	231HA, 231HA-2
231-TK2	231C, 231HA, 231HA-2
231-TK3	231C, 231HA, 231HA-2
231XP-TK1	231XP, 231C, 231HA, 231HA-2
244-TK2	244A, 244A-2

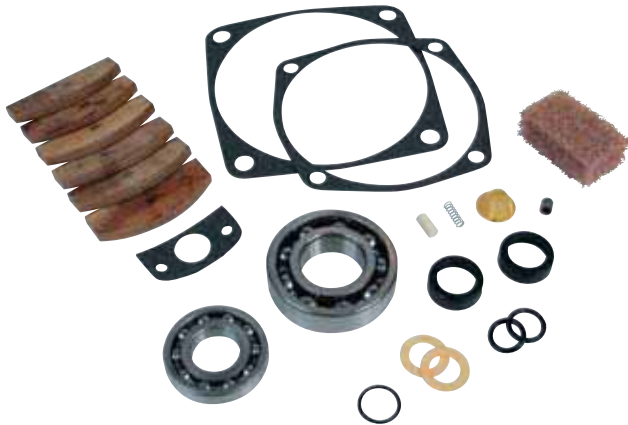

Part Number	For Use With
3/4" IMPACTOOL TUNE-UP KITS	
261-TK2	261, 261-3, 261-6, 271
2141-TK1	2141
2161-TK2	2161XP, 2161XP-6
252-TK2	252
1" IMPACTOOL TUNE-UP KITS	
280-TK2	280, 280-6, 280-S6
285B-TK1	285B, 285B-6, 285B-S6
295A-TK1	295A
2190-TK1	2190Ti, 2190DTi-6, 2190Ti-6
290-TK2	290

Impactool Hammer Throttle Valve Body Kit

Part Number	For Use With
IMPACTOOL THROTTLE VALVE BODY KIT	
223-TVB1	223



223-TVB1

Impactool Hammer and Anvil Kits

Part Number	For Use With
3/8" IMPACTOOL HAMMER AND ANVIL KITS	
2112-THK1	2112
2115-THK2	2115TiMAX Series
216-THK2	216
1/2" IMPACTOOL HAMMER AND ANVIL KITS	
2130-IMK1	2130
2130-IMK2	2130-2
2135-THK1	2135TiMAX, 2135QTiMAX
2135-2-THK1	2135Ti-2MAX, 2135QTi-2MAX
231B-HK	231C, 231HA, 231HA-2
231B-THK1	231C, 231HA, 231HA-3
231B-THK2	231C, 231HA, 231HA-2
3/4" IMPACTOOL HAMMER AND ANVIL KITS	
261-THK1	261
2141-THK1	2141
1" IMPACTOOL HAMMER AND ANVIL KITS	
2190-THK1	2190Ti
285A-6-THK1	285B
2190-6-THK1	2190Ti-6, 2190DTi-6



If your tools aren't working, neither are you! Protect your tools with genuine Ingersoll Rand parts and services.

Air Tool Lubricants

Regular tool lubrication will keep your tool running at peak performance for a longer time. Our full line of air tool lubricants can be found on page 124.

Ergonomic Accessories

Ingersoll Rand offers a handy line of ergonomic accessories that enable you to work more safely and more comfortably. Our tool boots absorb vibrations and protect the tool from external damage. Ingersoll Rand comfort grips protect you from mechanical shocks and tool vibration, and our braces allow for more consistent torque output and eliminate the need for a dead handle.

Protective Tool Boots

Part Number	Description	For Use With
PROTECTIVE TOOL BOOTS		
212-BOOT	Impactool boot with Ingersoll Rand logo printed on red boot	212
2115M-BOOT	Premium Impactool boot with Ingersoll Rand logo	2115TiMAX Series
2130-BOOT	Premium Impactool boot with Ingersoll Rand logo	2130, 2130-2
2135M-BOOT	Premium Impactool boot with Ingersoll Rand logo	2135TiMAX, 2135Ti-2MAX, 2135QTiMAX, 2135QTi-2MAX, 2135QPTiMAX
2141-BOOT	Premium Impactool boot with Ingersoll Rand logo	2141
215-BOOT	Impactool boot with Ingersoll Rand logo printed on red boot	215
2161-BOOT	Impactool boot with Ingersoll Rand logo printed on red boot	2161XP, 2161XP-6
2190-BOOT	Premium Impactool boot with Ingersoll Rand logo	2190Ti, 2190Ti-6

- Specifically designed for use with our air Impacttools
- Keep your tools clean and protected from external damage



212-BOOT



2135M-BOOT

285B Replacement Boots

Part Number	Description	For Use With
PROTECTIVE TOOL BOOTS		
431L-62	Rubber hammer case guard	285B, 285B-6, 285B-S6
431L-32	Rubber motor housing guard	285B, 285B-6, 285B-S6



431L-62



431L-32

Part Number	Description	For Use With
PROTECTIVE TOOL BOOTS		
236-BOOT	Impactool boot with Ingersoll Rand logo printed on red boot	236
244-BOOT	Impactool boot with Ingersoll Rand logo printed on red boot	244A, 244A-2
261-BOOT	Impactool boot with Ingersoll Rand logo printed on red boot	261, 261-3, 261-6
285-BOOT	Impactool boot with Ingersoll Rand logo printed on red boot	285B, 285B-6
295-BOOT	Impactool boot with Ingersoll Rand logo printed on red boot	295, 295A, 295-S
231-BOOT	Impactool boot with Ingersoll Rand logo printed on red boot	231C, 231HA, 231HA-2
232TGSL-P32	ThunderGun Street Legal Impactool boot	232TGSL



231-BOOT



232TGSL-P32



Light Holder Boots

Part Number	Description	For Use With
2115M-BOOT-LED	Premium boot with LED flashlight holder (kit includes LED flashlight)	2115TiMAX Series
231-BOOT-LED	Premium boot with LED flashlight holder (kit includes LED flashlight)	231
2135M-BOOT-LED	Premium boot with LED flashlight holder (kit includes LED flashlight)	2135TiMAX Series



2115M-BOOT-LED



231-BOOT-LED



2135M-BOOT-LED

Comfort Grips

Part Number	Description	For Use With
IMPACTOOL GRIPS		
CG-6X8	6" x 8" sheet of comfort-grip material	All tools

- Cut to size to fit your tool

Sockets



Backed by a proud heritage of reliability and innovation, Ingersoll Rand introduces a comprehensive line of industrial-grade sockets consistent with the quality of our best-in-class Impacttools.

- Impact-grade chrome-molybdenum steel provides the durability you expect from a global leader
- Highly visible laser etching for easy size identification
- Nearly 800 Impacttool socket items for virtually any assembly or disassembly job
- Lifetime warranty

From air compressors to Impacttools to sockets (and everything in between), Ingersoll Rand provides the toughest, highest quality products available.

Industrial-grade Impact Sockets

Backed by a proud heritage of reliability and innovation, Ingersoll Rand introduces a comprehensive line of industrial-grade sockets consistent with the quality of our best-in-class Impacttools.

Features and Benefits

Features	Benefits
A Impact-grade toughness	Designed for high-torque applications
B Chrome-molybdenum steel	Forged for high-strength durability
C Laser-etched size labeling	Enables easier identification to get the job done faster
D Electro-phosphate finish	Projects a sleeker look for higher visibility
E Backed by a lifetime warranty	Provides peace of mind with proven reliability

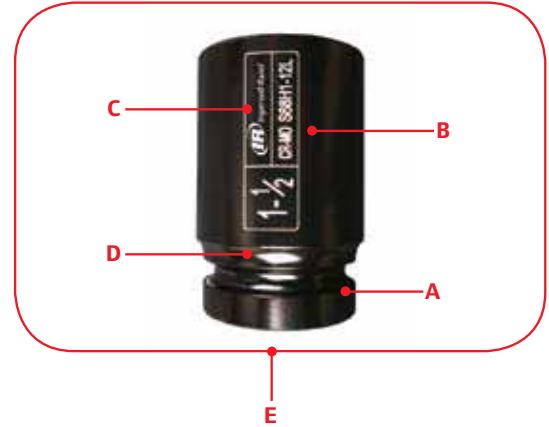

1/4" Square Drive Sockets

Universal

Part Number	Output Size	Type	D1 in (mm)	D2 in (mm)	T in (mm)	L in (mm)
SAE (in)						
S62H14U	1/4"	A	0.47" (12)	0.63" (16)	0.23" (6)	1.73" (44)
S62H516U	5/16"	A	0.51" (13)	0.63" (16)	0.23" (6)	1.73" (44)
S62H38U	3/8"	A	0.63" (16)	0.63" (16)	0.31" (8)	1.73" (44)
S62H716U	7/16"	A	0.66" (17)	0.63" (16)	0.31" (8)	1.73" (44)
S62H12U	1/2"	A	0.74" (19)	0.63" (16)	0.31" (8)	1.89" (48)
S62H916U	9/16"	A	0.78" (20)	0.63" (16)	0.31" (8)	1.89" (48)
METRIC (mm)						
S62M5U	5	A	0.47 (12)	0.63 (16)	0.23 (6)	1.73 (44)
S62M55U	5.5	A	0.47 (12)	0.7 (18)	0.23 (6)	1.73 (44)
S62M6U	6	A	0.47 (12)	0.7 (18)	0.23 (6)	1.73 (44)
S62M7U	7	A	0.47 (12)	0.7 (18)	0.23 (6)	1.73 (44)
S62M8U	8	A	0.51 (13)	0.7 (18)	0.31 (8)	1.73 (44)
S62M9U	9	A	0.59 (15)	0.7 (18)	0.31 (8)	1.73 (44)
S62M10U	10	A	0.63 (16)	0.7 (18)	0.31 (8)	1.73 (44)
S62M11U	11	A	0.66 (17)	0.7 (18)	0.31 (8)	1.73 (44)
S62M12U	12	A	0.66 (17)	0.7 (18)	0.31 (8)	1.89 (48)
S62M13U	13	A	0.74 (19)	0.7 (18)	0.31 (8)	1.89 (48)
S62M14U	14	A	0.78 (20)	0.7 (18)	0.31 (8)	1.89 (48)
S62M15U	15	A	0.82 (21)	0.7 (18)	0.31 (8)	1.89 (48)



Adapters

Part Number	Output Drive Size	Description
A2F3M	3/8"	1/4" F to 3/8" M
J2	1/4"	Universal joint



Extensions

Part Number	Output Drive Size	Description
E22H	1/4"	2" extension
E24H	1/4"	4" extension
E26H	1/4"	6" extension



1/4" Square Drive Sockets

Standard

Part Number	Output Size	Type	D1 in (mm)	D2 in (mm)	T in (mm)	L in (mm)
SAE (in)						
S62H316	3/16"	A	0.33" (8.5)	0.51" (13)	0.19" (5)	0.9" (23)
S62H732	7/32"	A	0.37" (9.5)	0.51" (13)	0.19" (5)	0.9" (23)
S62H14	1/4"	A	0.4" (10.3)	0.51" (13)	0.19" (5)	0.9" (23)
S62H932	9/32"	A	0.44" (11.3)	0.51" (13)	0.27" (7)	0.9" (23)
S62H516	5/16"	A	0.49" (12.5)	0.51" (13)	0.27" (7)	0.9" (23)
S62H1132	11/32"	B	0.55" (14)	0.55" (14)	0.27" (7)	0.9" (23)
S62H38	3/8"	B	0.63" (16)	0.63" (16)	0.31" (8)	0.9" (23)
S62H716	7/16"	B	0.66" (17)	0.66" (17)	0.31" (8)	0.9" (23)
S62H12	1/2"	B	0.74" (19)	0.74" (19)	0.31" (8)	0.9" (23)
S62H916	9/16"	B	0.78" (20)	0.78" (20)	0.31" (8)	0.9" (23)
METRIC (mm)						
S62M4	4	A	0.29 (7.6)	0.51 (13)	0.19 (5)	0.9 (23)
S62M45	4.5	A	0.32 (8.2)	0.51 (13)	0.19 (5)	0.9 (23)
S62M5	5	A	0.346 (8.8)	0.51 (13)	0.19 (5)	0.9 (23)
S62M55	5.5	A	0.37 (9.5)	0.51 (13)	0.19 (5)	0.9 (23)
S62M6	6	A	0.39 (10)	0.51 (13)	0.27 (7)	0.9 (23)
S62M7	7	A	0.44 (11.3)	0.51 (13)	0.27 (7)	0.9 (23)
S62M8	8	A	0.49 (12.5)	0.51 (13)	0.27 (7)	0.9 (23)
S62M9	9	B	0.55 (14)	0.55 (14)	0.27 (7)	0.9 (23)
S62M10	10	B	0.57 (14.5)	0.57 (14.5)	0.27 (7)	0.9 (23)
S62M11	11	B	0.66 (17)	0.66 (17)	0.31 (8)	0.9 (23)
S62M12	12	B	0.7 (18)	0.7 (18)	0.31 (8)	0.9 (23)
S62M13	13	B	0.74 (19)	0.74 (19)	0.31 (8)	0.9 (23)
S62M14	14	B	0.78 (20)	0.78 (20)	0.31 (8)	0.9 (23)
S62M15	15	B	0.82 (21)	0.82 (21)	0.31 (8)	0.9 (23)

Deep

Part Number	Output Size	Type	D1 in (mm)	D2 in (mm)	T in (mm)	L in (mm)
SAE (in)						
S62H316L	3/16"	A	0.33" (8.5)	0.51" (13)	0.19" (5)	1.96" (50)
S62H732L	7/32"	A	0.37" (9.5)	0.51" (13)	0.19" (5)	1.96" (50)
S62H14L	1/4"	A	0.4" (10.3)	0.51" (13)	0.19" (5)	1.96" (50)
S62H932L	9/32"	A	0.44" (11.3)	0.51" (13)	0.27" (7)	1.96" (50)
S62H516L	5/16"	A	0.49" (12.5)	0.51" (13)	0.27" (7)	1.96" (50)
S62H1132L	11/32"	B	0.55" (14)	0.55" (14)	0.27" (7)	1.96" (50)
S62H38L	3/8"	B	0.63" (16)	0.63" (16)	0.31" (8)	1.96" (50)
S62H716L	7/16"	B	0.66" (17)	0.66" (17)	0.31" (8)	1.96" (50)
S62H12L	1/2"	B	0.74" (19)	0.74" (19)	0.31" (8)	1.96" (50)
S62H916L	9/16"	B	0.78" (20)	0.78" (20)	0.31" (8)	1.96" (50)
METRIC (mm)						
S62M4L	4	A	0.29 (7.6)	0.51 (13)	0.19 (5)	1.96 (50)
S62M45L	4.5	A	0.32 (8.2)	0.51 (13)	0.19 (5)	1.96 (50)
S62M5L	5	A	0.34 (8.8)	0.51 (13)	0.19 (5)	1.96 (50)
S62M55L	5.5	A	0.37 (9.5)	0.51 (13)	0.19 (5)	1.96 (50)
S62M6L	6	A	0.39 (10)	0.51 (13)	0.27 (7)	1.96 (50)
S62M7L	7	A	0.44 (11.3)	0.51 (13)	0.27 (7)	1.96 (50)
S62M8L	8	A	0.49 (12.5)	0.51 (13)	0.27 (7)	1.96 (50)
S62M9L	9	B	0.57 (14.5)	0.57 (14.5)	0.27 (7)	1.96 (50)
S62M10L	10	B	0.63 (16)	0.63 (16)	0.27 (7)	1.96 (50)
S62M11L	11	B	0.66 (17)	0.66 (17)	0.31 (8)	1.96 (50)
S62M12L	12	B	0.66 (17)	0.66 (17)	0.31 (8)	1.96 (50)
S62M13L	13	B	0.74 (19)	0.74 (19)	0.31 (8)	1.96 (50)
S62M14L	14	B	0.78 (20)	0.78 (20)	0.31 (8)	1.96 (50)
S62M15L	15	B	0.82 (21)	0.82 (21)	0.31 (8)	1.96 (50)



SK2C10



SK2M12

Sets

Part Number	Pieces	Description	Contents
SK2C10	10	1/4" drive combo SAE and metric standard socket set	3/16", 1/4", 3/8", 1/2", 9/16", 4 mm, 6 mm, 10 mm, 12 mm, 14 mm
SK2M12	12	1/4" drive metric standard socket set	6 mm, 7 mm, 8 mm, 9 mm, 10 mm, 11 mm, 12 mm, 13 mm, 14 mm, 50 mm extension, 10 mm extension, 3/8" F to 1/4" M adapter

3/8" Square Drive Socket

Sets

Part Number	Pieces	Description	Contents
SK3H8	8	3/8" drive SAE standard socket set	5/16", 3/8", 7/16", 1/2", 9/16", 5/8", 11/16", 3/4"
SK3H8L	8	3/8" drive SAE deep socket set	5/16", 3/8", 7/16", 1/2", 9/16", 5/8", 11/16", 3/4"
SK3H7U	7	3/8" drive SAE universal socket set	3/8", 7/16", 1/2", 9/16", 5/8", 11/16", 3/4"
SK3M8	8	3/8" drive metric standard socket set	9 mm, 10 mm, 11 mm, 13 mm, 14 mm, 15 mm, 17 mm, 19 mm
SK3M8L	8	3/8" drive metric deep socket set	9 mm, 10 mm, 11 mm, 13 mm, 14 mm, 15 mm, 17 mm, 19 mm
SK3M10	10	3/8" drive metric standard socket set	9 mm, 10 mm, 11 mm, 12 mm, 13 mm, 14 mm, 15 mm, 16 mm, 17 mm, 19 mm
SK3M7U	7	3/8" drive metric universal socket set	10 mm, 12 mm, 13 mm, 14 mm, 15 mm, 17 mm, 19 mm
SK3C8	8	3/8" drive combo SAE and metric standard socket set	3/8", 1/2", 5/8", 11/16", 10 mm, 13 mm, 16 mm, 17 mm



SK3H8



SK3H8L



SK3H7U



SK3M8



SK3M8L



SK3M10



SK3M7U



SK3C8

3/8" Square Drive Sockets

Standard

Part Number	Output Size	Type	D1 in (mm)	D2 in (mm)	T in (mm)	L in (mm)
SAE (in)						
S63H14	1/4"	A	0.43" (11)	0.74" (19)	0.15" (4)	1.1" (28)
S63H516	5/16"	A	0.49" (12.5)	0.74" (19)	0.27" (7)	1.1" (28)
S63H38	3/8"	A	0.57" (14.5)	0.74" (19)	0.27" (7)	1.1" (28)
S63H716	7/16"	A	0.66" (17)	0.74" (19)	0.27" (7)	1.18" (30)
S63H12	1/2"	B	0.74" (19)	0.74" (19)	0.27" (7)	1.18" (30)
S63H916	9/16"	B	0.78" (20)	0.78" (20)	0.27" (7)	1.18" (30)
S63H58	5/8"	B	0.94" (24)	0.94" (24)	0.39" (10)	1.18" (30)
S63H1116	11/16"	B	0.94" (24)	0.94" (24)	0.39" (10)	1.26" (32)
S63H34	3/4"	B	1.02" (26)	1.02" (26)	0.39" (10)	1.26" (32)
S63H1316	13/16"	B	1.18" (30)	1.18" (30)	0.51" (13)	1.26" (32)
S63H78	7/8"	B	1.26" (32)	1.26" (32)	0.51" (13)	1.26" (32)
S63H1516	15/16"	B	1.33" (34)	1.33" (34)	0.51" (13)	1.26" (32)
S63H1	1"	B	1.33" (34)	1.33" (34)	0.51" (13)	1.26" (32)
METRIC (mm)						
S63M6	6	A	0.41 (10.5)	0.74 (19)	0.15 (4)	1.1 (28)
S63M7	7	A	0.45 (11.5)	0.74 (19)	0.27 (7)	1.1 (28)
S63M8	8	A	0.49 (12.5)	0.74 (19)	0.27 (7)	1.1 (28)
S63M9	9	A	0.55 (14)	0.74 (19)	0.27 (7)	1.1 (28)
S63M10	10	A	0.59 (15)	0.74 (19)	0.27 (7)	1.1 (28)
S63M11	11	A	0.66 (17)	0.74 (19)	0.27 (7)	1.18 (30)
S63M12	12	B	0.7 (18)	0.74 (19)	0.27 (7)	1.18 (30)
S63M13	13	B	0.74 (19)	0.74 (19)	0.27 (7)	1.18 (30)
S63M14	14	B	0.78 (20)	0.78 (20)	0.27 (7)	1.18 (30)
S63M15	15	B	0.86 (22)	0.86 (22)	0.39 (10)	1.18 (30)
S63M16	16	B	0.94 (24)	0.94 (24)	0.39 (10)	1.18 (30)
S63M17	17	B	0.94 (24)	0.94 (24)	0.39 (10)	1.26 (32)
S63M18	18	B	1.02 (26)	1.02 (26)	0.51 (13)	1.26 (32)
S63M19	19	B	1.02 (26)	1.02 (26)	0.51 (13)	1.26 (32)
S63M20	20	B	1.1 (28)	1.1 (28)	0.51 (13)	1.26 (32)
S63M21	21	B	1.18 (30)	1.18 (30)	0.51 (13)	1.26 (32)
S63M22	22	B	1.26 (32)	1.26 (32)	0.51 (13)	1.26 (32)



Deep

Part Number	Output Size	Type	D1 in (mm)	D2 in (mm)	T in (mm)	L in (mm)
SAE (in)						
S63H516L	5/16"	A	0.49" (12.5)	0.74" (19)	0.47" (12)	2.48" (63)
S63H38L	3/8"	A	0.57" (14.5)	0.74" (19)	0.55" (14)	2.48" (63)
S63H716L	7/16"	A	0.66" (17)	0.74" (19)	0.66" (17)	2.48" (63)
S63H12L	1/2"	B	0.74" (19)	0.74" (19)	0.66" (17)	2.48" (63)
S63H916L	9/16"	B	0.78" (20)	0.78" (20)	0.66" (17)	2.48" (63)
S63H58L	5/8"	B	0.94" (24)	0.94" (24)	0.66" (17)	2.48" (63)
S63H1116L	11/16"	B	0.94" (24)	0.94" (24)	0.66" (17)	2.48" (63)
S63H34L	3/4"	B	1.02" (26)	1.02" (26)	0.74" (19)	2.48" (63)
S63H1316L	13/16"	B	1.18" (30)	1.18" (30)	0.74" (19)	2.48" (63)
S63H78L	7/8"	B	1.26" (32)	1.26" (32)	0.74" (19)	2.48" (63)
S63H1516L	15/16"	B	1.33" (34)	1.33" (34)	0.82" (21)	2.48" (63)
S63H1L	1"	B	1.41" (36)	1.41" (36)	0.82" (21)	2.48" (63)
METRIC (mm)						
S63M7L	7	A	0.45 (11.5)	0.74 (19)	0.43 (11)	2.48 (63)
S63M8L	8	A	0.49 (12.5)	0.74 (19)	0.47 (12)	2.48 (63)
S63M9L	9	A	0.55 (14)	0.74 (19)	0.55 (14)	2.48 (63)
S63M10L	10	A	0.59 (15)	0.74 (19)	0.55 (14)	2.48 (63)
S63M11L	11	A	0.66 (17)	0.74 (19)	0.66 (17)	2.48 (63)
S63M12L	12	B	0.7 (18)	0.74 (19)	0.66 (17)	2.48 (63)
S63M13L	13	B	0.74 (19)	0.74 (19)	0.66 (17)	2.48 (63)
S63M14L	14	B	0.78 (20)	0.78 (20)	0.66 (17)	2.48 (63)
S63M15L	15	B	0.86 (22)	0.86 (22)	0.74 (19)	2.48 (63)
S63M16L	16	B	0.94 (24)	0.94 (24)	0.74 (19)	2.48 (63)
S63M17L	17	B	0.94 (24)	0.94 (24)	0.74 (19)	2.48 (63)
S63M18L	18	B	1.02 (26)	1.02 (26)	0.74 (19)	2.48 (63)
S63M19L	19	B	1.02 (26)	1.02 (26)	0.82 (21)	2.48 (63)
S63M20L	20	B	1.1 (28)	1.1 (28)	0.82 (21)	2.48 (63)
S63M21L	21	B	1.18 (30)	1.18 (30)	0.82 (21)	2.48 (63)
S63M22L	22	B	1.26 (32)	1.26 (32)	0.82 (21)	2.48 (63)



3/8" Square Drive Sockets

Universal

Part Number	Output Size	Type	D1 in (mm)	D2 in (mm)	T in (mm)	L in (mm)
SAE (in)						
S63H516U	5/16"	A	0.68" (17.5)	0.94" (24)	0.47" (12)	2.08" (53)
S63H38U	3/8"	A	0.59" (15)	0.94" (24)	0.47" (12)	2.08" (53)
S63H716U	7/16"	A	0.72" (18.5)	0.94" (24)	0.47" (12)	2.08" (53)
S63H12U	1/2"	A	0.74" (19)	0.94" (24)	0.47" (12)	2.08" (53)
S63H916U	9/16"	A	0.86" (22)	0.94" (24)	0.47" (12)	2.08" (53)
S63H58U	5/8"	A	0.94" (24)	0.94" (24)	0.47" (12)	2.08" (53)
S63H1116U	11/16"	A	0.98" (25)	0.94" (24)	0.47" (12)	2.08" (53)
S63H34U	3/4"	A	1.1" (28)	0.94" (24)	0.47" (12)	2.08" (53)
S63H1316U	13/16"	A	1.26" (32)	0.94" (24)	0.47" (12)	2.08" (53)
S63H78U	7/8"	A	1.26" (32)	0.94" (24)	0.47" (12)	2.08" (53)
S63H1516U	15/16"	A	1.33" (34)	0.94" (24)	0.47" (12)	2.08" (53)
S63H1U	15"	A	1.41" (36)	0.94" (24)	0.47" (12)	2.08" (53)
METRIC (mm)						
S63M8U	8	A	0.68 (17.5)	0.94 (24)	0.47 (12)	2.08 (53)
S63M9U	9	A	0.68 (17.5)	0.94 (24)	0.47 (12)	2.08 (53)
S63M10U	10	A	0.65 (16.5)	0.94 (24)	0.47 (12)	2.08 (53)
S63M11U	11	A	0.74 (19)	0.94 (24)	0.47 (12)	2.08 (53)
S63M12U	12	A	0.74 (19)	0.94 (24)	0.47 (12)	2.08 (53)
S63M13U	13	A	0.78 (20)	0.94 (24)	0.47 (12)	2.08 (53)
S63M14U	14	A	0.86 (22)	0.94 (24)	0.47 (12)	2.08 (53)
S63M15U	15	A	0.86 (22)	0.94 (24)	0.47 (12)	2.08 (53)
S63M16U	16	A	1.02 (26)	0.94 (24)	0.47 (12)	2.08 (53)
S63M17U	17	A	1.02 (26)	0.94 (24)	0.47 (12)	2.08 (53)
S63M18U	18	A	1.02 (26)	0.94 (24)	0.47 (12)	2.08 (53)
S63M19U	19	A	1.1 (28)	0.94 (24)	0.47 (12)	2.08 (53)
S63M20U	20	A	1.26 (32)	0.94 (24)	0.47 (12)	2.08 (53)
S63M21U	21	A	1.26 (32)	0.94 (24)	0.47 (12)	2.08 (53)
S63M22U	22	A	1.26 (32)	0.94 (24)	0.47 (12)	2.08 (53)



Adapters

Part Number	Output Drive Size	Description
A3F2M	1/4"	3/8" F to 1/4" M
A3F4M	1/2"	3/8" F to 1/2" M
J3	3/8"	Universal joint



Deep Universal

Part Number	Output Size	Type	D1 in (mm)	D2 in (mm)	T in (mm)	L in (mm)
SAE (in)						
S63H516UL	5/16"	A	0.68" (17.5)	0.94" (24)	0.51" (13)	3.03" (77)
S63H38UL	3/8"	A	0.7" (18)	0.94" (24)	0.51" (13)	3.03" (77)
S63H716UL	7/16"	A	0.7" (18)	0.94" (24)	0.51" (13)	3.03" (77)
S63H12UL	1/2"	A	0.74" (19)	0.94" (24)	0.51" (13)	3.03" (77)
S63H916UL	9/16"	A	0.82" (21)	0.94" (24)	0.51" (13)	3.03" (77)
S63H58UL	5/8"	A	0.9" (23)	0.94" (24)	0.51" (13)	3.03" (77)
S63H1116UL	11/16"	A	0.98" (25)	0.94" (24)	0.51" (13)	3.03" (77)
S63H34UL	3/4"	A	1.06" (27)	0.94" (24)	0.51" (13)	3.03" (77)
S63H1316UL	13/16"	A	1.18" (30)	0.94" (24)	0.51" (13)	3.03" (77)
S63H78UL	7/8"	A	1.26" (32)	0.94" (24)	0.51" (13)	3.03" (77)
METRIC (mm)						
S63M8UL	8	A	0.68 (17.5)	0.94 (24)	0.51 (13)	3.03 (77)
S63M9UL	9	A	0.68 (17.5)	0.94 (24)	0.51 (13)	3.03 (77)
S63M10UL	10	A	0.7 (18)	0.94 (24)	0.51 (13)	3.03 (77)
S63M11UL	11	A	0.7 (18)	0.94 (24)	0.51 (13)	3.03 (77)
S63M12UL	12	A	0.74 (19)	0.94 (24)	0.51 (13)	3.03 (77)
S63M13UL	13	A	0.74 (19)	0.94 (24)	0.51 (13)	3.03 (77)
S63M14UL	14	A	0.82 (21)	0.94 (24)	0.51 (13)	3.03 (77)
S63M15UL	15	A	0.86 (22)	0.94 (24)	0.51 (13)	3.03 (77)
S63M16UL	16	A	1.02 (26)	0.94 (24)	0.51 (13)	3.03 (77)
S63M17UL	17	A	0.98 (25)	0.94 (24)	0.51 (13)	3.03 (77)
S63M18UL	18	A	1.02 (26)	0.94 (24)	0.51 (13)	3.03 (77)
S63M19UL	19	A	1.06 (27)	0.94 (24)	0.51 (13)	3.03 (77)
S63M20UL	20	A	1.1 (28)	0.94 (24)	0.51 (13)	3.03 (77)
S63M21UL	21	A	1.18 (30)	0.94 (24)	0.51 (13)	3.03 (77)
S63M22UL	22	A	1.26 (32)	0.94 (24)	0.51 (13)	3.03 (77)



Extensions

Part Number	Output Drive Size	Description
E33H	3/8"	3" extension
E36H	3/8"	6" extension
E312H	3/8"	12" extension



1/2" Square Drive Sockets

Sets

Part Number	Pieces	Description	Contents
SK4H13	13	1/2" drive SAE standard socket set	7/16", 1/2", 9/16", 5/8", 11/16", 3/4", 13/16", 7/8", 15/16", 1", 1-1/16", 1-1/8", 1-1/4"
SK4H13L	13	1/2" drive SAE deep socket set	7/16", 1/2", 9/16", 5/8", 11/16", 3/4", 13/16", 7/8", 15/16", 1", 1-1/16", 1-1/8", 1-1/4"
SK4H7U	7	1/2" drive SAE universal socket set	1/2", 9/16", 5/8", 11/16", 3/4", 13/16", 7/8"
SK4M14	14	1/2" drive metric standard socket set	10 mm, 11 mm, 12 mm, 13 mm, 14 mm, 15 mm, 16 mm, 17 mm, 18 mm, 19 mm, 21 mm, 22 mm, 26 mm, 27 mm
SK4M14L	14	1/2" drive metric deep socket set	10 mm, 11 mm, 12 mm, 13 mm, 14 mm, 15 mm, 16 mm, 17 mm, 18 mm, 19 mm, 21 mm, 22 mm, 26 mm, 27 mm
SK4M4L	4	1/2" drive metric deep axle nut service socket set	30 mm, 32 mm, 34 mm, 36 mm
SK4M7U	7	1/2" drive metric universal socket set	13 mm, 14 mm, 15 mm, 17 mm, 19 mm, 21 mm, 22 mm
SK4C3F	3	1/2" drive lug nut service flip socket set	3/4", 13/16", 19 mm x 21 mm, 3" extension
SK34C86	86	3/8" and 1/2" drive combo standard and deep socket set	Includes all sockets in SK3H8, SK3H8L, SK3M8, SK3M8L, SK4H13, SK4H13L, SK4M14, and SK4M14L
SK4M5L	5	1/2" drive deep socket set	17 mm, 19 mm, 21 mm, 22 mm, 24 mm
SK4M3L	3	1/2" drive metric deep protective socket set	17 mm, 19 mm, 21 mm
SK4M18	18	1/2" drive metric socket set	Standard: 10 mm, 11 mm, 13 mm, 14 mm, 17 mm, 19 mm, 21 mm, 22 mm, 24 mm Deep: 13 mm, 14 mm, 21 mm, 24 mm Deep Thin Wall: 17 mm, 19 mm, 21 mm, 125 mm extension, universal joint
SK4LNR	8	1/2" drive metric lug nut removal set	17 mm, 18.5 mm, 20 mm, 21.5 mm, 23 mm, 24.5 mm, 26 mm, 27.5 mm



SK4H13



SK4H13L



SK4H7U



SK4M14



SK4M14L



SK4M4L



SK4M7U



SK4C3F



SK34C86



SK4M5L



SK4M3L



SK4M18



SK4LNR

1/2" Square Drive Sockets

Standard

Part Number	Output Size	Type	D1 in (mm)	D2 in (mm)	T in (mm)	L in (mm)
SAE (in)						
S64H516	5/16"	A	0.55" (14)	0.86" (22)	0.35" (9)	1.49" (38)
S64H38	3/8"	A	0.63" (16)	0.86" (22)	0.43" (11)	1.49" (38)
S64H716	7/16"	A	0.7" (18)	0.86" (22)	0.43" (11)	1.49" (38)
S64H12	1/2"	A	0.76" (19.5)	0.86" (22)	0.43" (11)	1.49" (38)
S64H916	9/16"	A	0.84" (21.5)	0.94" (24)	0.43" (11)	1.49" (38)
S64H58	5/8"	B	0.94" (24)	0.94" (24)	0.43" (11)	1.49" (38)
S64H1116	11/16"	B	1.02" (26)	1.02" (26)	0.43" (11)	1.49" (38)
S64H34	3/4"	B	1.1" (28)	1.1" (28)	0.63" (16)	1.57" (40)
S64H1316	13/16"	B	1.18" (30)	1.18" (30)	0.63" (16)	1.57" (40)
S64H78	7/8"	B	1.26" (32)	1.26" (32)	0.63" (16)	1.65" (42)
S64H1516	15/16"	B	1.33" (34)	1.33" (34)	0.63" (16)	1.73" (44)
S64H1	1"	B	1.41" (36)	1.41" (36)	0.7" (18)	1.73" (44)
S64H1-116	1-1/16"	B	1.49" (38)	1.49" (38)	0.7" (18)	1.81" (46)
S64H1-18	1-1/8"	C	1.57" (40)	1.49" (38)	0.7" (18)	1.81" (46)
S64H1-316	1-3/16"	C	1.65" (42)	1.49" (38)	0.7" (18)	1.81" (46)
S64H1-14	1-1/4"	C	1.73" (44)	1.49" (38)	0.78" (20)	1.81" (46)
S64H1-516	1-5/16"	C	1.85" (47)	1.49" (38)	0.78" (20)	1.81" (46)
S64H1-38	1-3/8"	C	1.96" (50)	1.49" (38)	0.78" (20)	1.81" (46)
S64H1-716	1-7/16"	C	2" (51)	1.49" (38)	0.78" (20)	1.81" (46)
S64H1-12	1-1/2"	C	2.08" (53)	1.49" (38)	0.86" (22)	1.81" (46)
S64H1-916	1-9/16"	C	2.16" (55)	1.73" (44)	0.86" (22)	2.36" (60)
S64H1-58	1-5/8"	C	2.28" (58)	1.73" (44)	0.86" (22)	2.36" (60)
S64H1-1116	1-11/16"	C	2.4" (61)	1.73" (44)	0.94" (24)	2.36" (60)
S64H1-34	1-3/4"	C	2.48" (63)	1.73" (44)	0.94" (24)	2.36" (60)
S64H1-1316	1-13/16"	C	2.55" (65)	1.73" (44)	0.94" (24)	2.36" (60)
S64H1-78	1-7/8"	C	2.59" (66)	1.73" (44)	0.94" (24)	2.36" (60)
S64H1-1516	1-15/16"	C	2.67" (68)	1.73" (44)	0.94" (24)	2.36" (60)
S64H2	2"	C	2.75" (70)	2.04" (52)	0.94" (24)	2.36" (60)
S64H2-116	2-1/16"	C	2.83" (72)	2.04" (52)	0.94" (24)	2.36" (60)
S64H2-18	2-1/8"	C	2.99" (76)	2.04" (52)	1.06" (27)	2.55" (65)
S64H2-316	2-3/16"	C	3.03" (77)	2.04" (52)	1.06" (27)	2.55" (65)
S64H2-14	2-1/4"	C	3.15" (80)	2.04" (52)	1.06" (27)	2.55" (65)

Part Number	Output Size	Type	D1 in (mm)	D2 in (mm)	T in (mm)	L in (mm)
METRIC (mm)						
S64M8	8	A	0.57 (14.5)	0.86 (22)	0.35 (9)	1.49 (38)
S64M9	9	A	0.57 (14.5)	0.86 (22)	0.43 (11)	1.49 (38)
S64M10	10	A	0.66 (17)	0.86 (22)	0.43 (11)	1.49 (38)
S64M11	11	A	0.66 (17)	0.86 (22)	0.43 (11)	1.49 (38)
S64M12	12	A	0.7 (18)	0.86 (22)	0.43 (11)	1.49 (38)
S64M13	13	A	0.78 (20)	0.86 (22)	0.43 (11)	1.49 (38)
S64M14	14	A	0.86 (22)	0.94 (24)	0.43 (11)	1.49 (38)
S64M15	15	A	0.94 (24)	0.94 (24)	0.43 (11)	1.49 (38)
S64M16	16	B	0.94 (24)	0.94 (24)	0.43 (11)	1.49 (38)
S64M17	17	B	1.02 (26)	1.02 (26)	0.43 (11)	1.49 (38)
S64M18	18	B	1.02 (26)	1.02 (26)	0.43 (11)	1.49 (38)
S64M19	19	B	1.1 (28)	1.1 (28)	0.51 (13)	1.57 (40)
S64M20	20	B	1.18 (30)	1.18 (30)	0.51 (13)	1.57 (40)
S64M21	21	B	1.18 (30)	1.18 (30)	0.51 (13)	1.57 (40)
S64M22	22	B	1.26 (32)	1.26 (32)	0.51 (13)	1.65 (42)
S64M23	23	B	1.26 (32)	1.26 (32)	0.51 (13)	1.65 (42)
S64M24	24	B	1.33 (34)	1.33 (34)	0.59 (15)	1.73 (44)
S64M25	25	B	1.37 (35)	1.37 (35)	0.59 (15)	1.73 (44)
S64M26	26	B	1.41 (36)	1.41 (36)	0.59 (15)	1.73 (44)
S64M27	27	B	1.49 (38)	1.49 (38)	0.72 (18.3)	1.81 (46)
S64M28	28	C	1.57 (40)	1.49 (38)	0.72 (18.3)	1.81 (46)
S64M29	29	C	1.57 (40)	1.49 (38)	0.72 (18.3)	1.81 (46)
S64M30	30	C	1.65 (42)	1.49 (38)	0.72 (18.3)	1.81 (46)
S64M32	32	C	1.73 (44)	1.49 (38)	0.72 (18.3)	1.81 (46)
S64M33	33	C	1.77 (45)	1.49 (38)	0.78 (20)	1.81 (46)
S64M34	34	C	1.81 (46)	1.49 (38)	0.78 (20)	1.81 (46)
S64M35	35	C	1.89 (48)	1.49 (38)	0.78 (20)	1.81 (46)
S64M36	36	C	1.96 (50)	1.49 (38)	0.78 (20)	1.96 (50)



1/2" Square Drive Sockets

Deep

Part Number	Output Size	Type	D1 in (mm)	D2 in (mm)	T in (mm)	L in (mm)
SAE (in)						
S64H516L	5/16"	A	0.55" (14)	0.86" (22)	0.39" (10)	3.07" (78)
S64H38L	3/8"	A	0.66" (17)	0.86" (22)	0.55" (14)	3.07" (78)
S64H716L	7/16"	A	0.7" (18)	0.86" (22)	0.55" (14)	3.07" (78)
S64H12L	1/2"	A	0.78" (20)	0.86" (22)	0.55" (14)	3.07" (78)
S64H916L	9/16"	A	0.86" (22)	0.94" (24)	0.55" (14)	3.07" (78)
S64H58L	5/8"	B	0.94" (24)	0.94" (24)	0.55" (14)	3.07" (78)
S64H1116L	11/16"	B	1.02" (26)	1.02" (26)	0.66" (17)	3.07" (78)
S64H34L	3/4"	B	1.1" (28)	1.1" (28)	0.66" (17)	3.07" (78)
S64H1316L	13/16"	B	1.18" (30)	1.18" (30)	0.66" (17)	3.07" (78)
S64H78L	7/8"	B	1.26" (32)	1.26" (32)	0.74" (19)	3.07" (78)
S64H1516L	15/16"	B	1.33" (34)	1.33" (34)	0.74" (19)	3.07" (78)
S64H1L	1"	B	1.41" (36)	1.41" (36)	0.74" (19)	3.07" (78)
S64H1-116L	1-1/16"	B	1.49" (38)	1.49" (38)	0.74" (19)	3.07" (78)
S64H1-18L	1-1/8"	C	1.57" (40)	1.49" (38)	0.74" (19)	3.07" (78)
S64H1-316L	1-3/16"	C	1.65" (42)	1.49" (38)	0.74" (19)	3.07" (78)
S64H1-14L	1-1/4"	C	1.73" (44)	1.49" (38)	1.18" (30)	3.07" (78)
S64H1-516L	1-5/16"	C	1.85" (47)	1.49" (38)	1.18" (30)	3.15" (80)
S64H1-38L	1-3/8"	C	1.96" (50)	1.49" (38)	1.18" (30)	3.15" (80)
S64H1-716L	1-7/16"	C	2" (51)	1.49" (38)	1.18" (30)	3.15" (80)
S64H1-12L	1-1/2"	C	2.08" (53)	1.49" (38)	1.18" (30)	3.15" (80)
S64H1-916L	1-9/16"	C	2.16" (55)	1.73" (44)	1.29" (33)	3.54" (90)
S64H1-58L	1-5/8"	C	2.28" (58)	1.73" (44)	1.29" (33)	3.54" (90)
S64H1-1116L	1-11/16"	C	2.4" (61)	1.73" (44)	1.29" (33)	3.54" (90)
S64H1-34L	1-3/4"	C	2.48" (63)	1.73" (44)	1.29" (33)	3.54" (90)
S64H1-1316L	1-13/16"	C	2.55" (65)	1.73" (44)	1.37" (35)	3.54" (90)
S64H1-78L	1-7/8"	C	2.59" (66)	1.73" (44)	1.37" (35)	3.54" (90)
S64H1-1516L	1-15/16"	C	2.67" (68)	1.73" (44)	1.37" (35)	3.54" (90)
S64H2L	2"	C	2.75" (70)	2.04" (52)	1.37" (35)	3.54" (90)
S64H2-116	2-1/16"	C	2.83" (72)	2.04" (52)	1.37" (35)	3.54" (90)
S64H2-18L	2-1/8"	C	2.99" (76)	2.04" (52)	1.37" (35)	3.54" (90)
S64H2-316L	2-3/16"	C	3.03" (77)	2.04" (52)	1.37" (35)	3.54" (90)
S64H2-14L	2-1/4"	C	3.15" (80)	2.04" (52)	1.37" (35)	3.54" (90)

Part Number	Output Size	Type	D1 in (mm)	D2 in (mm)	T in (mm)	L in (mm)
METRIC (mm)						
S64M8L	8	A	0.55 (14)	0.86 (22)	0.43 (11)	3.07 (78)
S64M9L	9	A	0.59 (15)	0.86 (22)	0.55 (14)	3.07 (78)
S64M10L	10	A	0.66 (17)	0.86 (22)	0.55 (14)	3.07 (78)
S64M11L	11	A	0.7 (18)	0.86 (22)	0.55 (14)	3.07 (78)
S64M12L	12	A	0.74 (19)	0.86 (22)	0.55 (14)	3.07 (78)
S64M13L	13	A	0.78 (20)	0.94 (24)	0.55 (14)	3.07 (78)
S64M14L	14	A	0.86 (22)	0.94 (24)	0.74 (19)	3.07 (78)
S64M15L	15	A	0.94 (24)	0.94 (24)	0.74 (19)	3.07 (78)
S64M16L	16	B	0.94 (24)	0.94 (24)	0.74 (19)	3.07 (78)
S64M17L	17	B	1.02 (26)	1.02 (26)	0.74 (19)	3.07 (78)
S64M18L	18	B	1.02 (26)	1.02 (26)	0.74 (19)	3.07 (78)
S64M19L	19	B	1.1 (28)	1.1 (28)	0.74 (19)	3.07 (78)
S64M20L	20	B	1.18 (30)	1.18 (30)	0.74 (19)	3.07 (78)
S64M21L	21	B	1.18 (30)	1.18 (30)	0.82 (21)	3.07 (78)
S64M22L	22	B	1.26 (32)	1.26 (32)	0.82 (21)	3.07 (78)
S64M23L	23	B	1.26 (32)	1.26 (32)	0.82 (21)	3.07 (78)
S64M24L	24	B	1.33 (34)	1.33 (34)	0.82 (21)	3.07 (78)
S64M25L	25	B	1.37 (35)	1.37 (35)	0.82 (21)	3.07 (78)
S64M26L	26	B	1.41 (36)	1.41 (36)	0.82 (21)	3.07 (78)
S64M27L	27	B	1.49 (38)	1.49 (38)	0.82 (21)	3.07 (78)
S64M28L	28	C	1.57 (40)	1.49 (38)	0.94 (24)	3.07 (78)
S64M29L	29	C	1.57 (40)	1.49 (38)	0.94 (24)	3.07 (78)
S64M30L	30	C	1.65 (42)	1.49 (38)	0.94 (24)	3.07 (78)
S64M32L	32	C	1.73 (44)	1.49 (38)	0.94 (24)	3.07 (78)
S64M33L	33	C	1.77 (45)	1.49 (38)	0.94 (24)	3.07 (78)
S64M34L	34	C	1.89 (48)	1.49 (38)	0.94 (24)	3.07 (78)
S64M35L	35	C	1.89 (48)	1.49 (38)	0.94 (24)	3.07 (78)
S64M36L	36	C	1.96 (50)	1.49 (38)	0.94 (24)	3.07 (78)



1/2" Square Drive Sockets

Universal

Part Number	Output Size	Type	D1 in (mm)	D2 in (mm)	T in (mm)	L in (mm)
SAE (in)						
S64H516U	5/16"	A	0.74" (19)	1.1" (28)	0.51" (13)	2.59" (66)
S64H38U	3/8"	A	0.74" (19)	1.1" (28)	0.51" (13)	2.59" (66)
S64H716U	7/16"	A	0.74" (19)	1.1" (28)	0.51" (13)	2.59" (66)
S64H12U	1/2"	A	0.74" (19)	1.1" (28)	0.51" (13)	2.59" (66)
S64H916U	9/16"	A	0.86" (22)	1.1" (28)	0.51" (13)	2.59" (66)
S64H58U	5/8"	A	0.94" (24)	1.1" (28)	0.51" (13)	2.59" (66)
S64H1116U	11/16"	A	1.02" (26)	1.1" (28)	0.51" (13)	2.59" (66)
S64H34U	3/4"	A	1.1" (28)	1.1" (28)	0.51" (13)	2.59" (66)
S64H1316U	13/16"	A	1.18" (30)	1.1" (28)	0.51" (13)	2.59" (66)
S64H78U	7/8"	A	1.26" (32)	1.1" (28)	0.51" (13)	2.59" (66)
S64H1516U	15/16"	A	1.41" (36)	1.1" (28)	0.51" (13)	2.59" (66)
METRIC (mm)						
S64M10U	10"	A	0.74 (19)	1.1 (28)	0.51 (13)	2.59 (66)
S64M11U	11"	A	0.74 (19)	1.1 (28)	0.51 (13)	2.59 (66)
S64M12U	12"	A	0.74 (19)	1.1 (28)	0.51 (13)	2.59 (66)
S64M13U	13"	A	0.86 (22)	1.1 (28)	0.51 (13)	2.59 (66)
S64M14U	14"	A	0.86 (22)	1.1 (28)	0.51 (13)	2.59 (66)
S64M15U	15"	A	0.9 (23)	1.1 (28)	0.51 (13)	2.59 (66)
S64M16U	16"	A	1.02 (26)	1.1 (28)	0.51 (13)	2.59 (66)
S64M17U	17"	A	1.02 (26)	1.1 (28)	0.51 (13)	2.59 (66)
S64M18U	18"	A	1.02 (26)	1.1 (28)	0.51 (13)	2.59 (66)
S64M19U	19"	A	1.1 (28)	1.1 (28)	0.51 (13)	2.59 (66)
S64M20U	20"	A	1.18 (30)	1.1 (28)	0.51 (13)	2.59 (66)
S64M21U	21"	A	1.18 (30)	1.1 (28)	0.51 (13)	2.59 (66)
S64M22U	22"	A	1.26 (32)	1.1 (28)	0.51 (13)	2.59 (66)
S64M23U	23"	A	1.26 (32)	1.1 (28)	0.51 (13)	2.59 (66)
S64M24U	24"	A	1.33 (34)	1.1 (28)	0.51 (13)	2.59 (66)



Adapters

Part Number	Output Drive Size	Description
A4F3M	3/4"	1/2" F to 3/8" M
A4F6M	3/4"	1/2" F to 3/4" M
J4	1/2"	Universal joint



Universal Deep

Part Number	Output Size	Type	D1 in (mm)	D2 in (mm)	T in (mm)	L in (mm)
SAE (in)						
S64H38UL	3/8"	A	0.86" (22)	1.1" (28)	0.55" (14)	3.54" (90)
S64H716UL	7/16"	A	0.86" (22)	1.1" (28)	0.66" (17)	3.54" (90)
S64H12UL	1/2"	A	0.86" (22)	1.1" (28)	0.66" (17)	3.54" (90)
S64H916UL	9/16"	A	0.86" (22)	1.1" (28)	0.66" (17)	3.54" (90)
S64H58UL	5/8"	A	0.94" (24)	1.1" (28)	0.66" (17)	3.54" (90)
S64H1116UL	11/16"	A	1.02" (26)	1.1" (28)	0.66" (17)	3.54" (90)
S64H34UL	3/4"	A	1.1" (28)	1.1" (28)	0.66" (17)	3.54" (90)
S64H1316UL	13/16"	A	1.18" (30)	1.1" (28)	0.66" (17)	3.54" (90)
S64H78UL	7/8"	A	1.26" (32)	1.1" (28)	0.66" (17)	3.54" (90)
S64H1516UL	15/16"	A	1.33" (34)	1.1" (28)	0.66" (17)	3.54" (90)
METRIC (mm)						
S64M10UL	10"	A	0.86 (22)	1.1 (28)	0.55 (14)	3.54 (90)
S64M11UL	11"	A	0.86 (22)	1.1 (28)	0.66 (17)	3.54 (90)
S64M12UL	12"	A	0.86 (22)	1.1 (28)	0.66 (17)	3.54 (90)
S64M13UL	13"	A	0.86 (22)	1.1 (28)	0.66 (17)	3.54 (90)
S64M14UL	14"	A	0.86 (22)	1.1 (28)	0.66 (17)	3.54 (90)
S64M15UL	15"	A	0.94 (24)	1.1 (28)	0.66 (17)	3.54 (90)
S64M16UL	16"	A	0.94 (24)	1.1 (28)	0.66 (17)	3.54 (90)
S64M17UL	17"	A	1.02 (26)	1.1 (28)	0.66 (17)	3.54 (90)
S64M18UL	18"	A	1.02 (26)	1.1 (28)	0.66 (17)	3.54 (90)
S64M19UL	19"	A	1.1 (28)	1.1 (28)	0.66 (17)	3.54 (90)
S64M20UL	20"	A	1.18 (30)	1.1 (28)	0.66 (17)	3.54 (90)
S64M21UL	21"	A	1.18 (30)	1.1 (28)	0.66 (17)	3.54 (90)
S64M22UL	22"	A	1.26 (32)	1.1 (28)	0.66 (17)	3.54 (90)
S64M23UL	23"	A	1.26 (32)	1.1 (28)	0.66 (17)	3.54 (90)
S64M24UL	24"	A	1.33 (34)	1.1 (28)	0.66 (17)	3.54 (90)



Extensions

Part Number	Output Drive Size	Description
E43H	1/2"	3" extension
E45H	1/2"	5" extension
E47H	1/2"	7" extension
E410H	1/2"	10" extension
E418H	1/2"	18" extra-long extension
E424H	1/2"	24" extra-long extension
E436H	1/2"	36" extra-long extension



3/4" Square Drive Sockets

Sets

Part Number	Pieces	Description	Contents
SK6H8	8	3/4" drive SAE standard socket set	1", 1-1/16", 1-1/8", 1-1/4", 1-5/16", 1-3/8", 1-7/16", 1-1/2"
SK6H8L	8	3/4" drive SAE deep socket set	1", 1-1/16", 1-1/8", 1-1/4", 1-5/16", 1-3/8", 1-7/16", 1-1/2"
SK6M6L	6	3/4" drive metric deep socket set	24 mm, 27 mm, 30 mm, 32 mm, 33 mm, 36 mm



SK6H8



SK6H8L



SK6M6L

Standard

Part Number	Output Size	Type	D1 in (mm)	D2 in (mm)	T in (mm)	L in (mm)
SAE (in)						
S66H12	1/2"	A	0.9" (23)	1.63" (41.4)	0.51" (13)	2" (51)
S66H916	9/16"	A	1" (25.5)	1.63" (41.4)	0.51" (13)	2" (51)
S66H58	5/8"	A	1.1" (28)	1.63" (41.4)	0.51" (13)	2" (51)
S66H1116	11/16"	A	1.16" (29.5)	1.63" (41.4)	0.51" (13)	2" (51)
S66H34	3/4"	A	1.26" (32)	1.63" (41.4)	0.51" (13)	2" (51)
S66H1316	13/16"	A	1.37" (35)	1.63" (41.4)	0.51" (13)	2" (51)
S66H78	7/8"	A	1.41" (36)	1.63" (41.4)	0.51" (13)	2" (51)
S66H1516	15/16"	A	1.51" (38.5)	1.63" (41.4)	0.51" (13)	2" (51)
S66H1	1"	A	1.57" (40)	1.63" (41.4)	0.51" (13)	2.08" (53)
S66H1-116	1-1/16"	A	1.67" (42.5)	1.73" (44)	0.51" (13)	2.08" (53)
S66H1-18	1-1/8"	B	1.73" (44)	1.73" (44)	0.63" (16)	2.08" (53)
S66H1-316	1-3/16"	C	1.81" (46)	1.73" (44)	0.63" (16)	2.08" (53)
S66H1-14	1-1/4"	C	1.89" (48)	1.73" (44)	0.63" (16)	2.24" (57)
S66H1-516	1-5/16"	C	1.96" (50)	1.73" (44)	0.74" (19)	2.24" (57)
S66H1-38	1-3/8"	C	2.06" (52.5)	1.73" (44)	0.74" (19)	2.24" (57)
S66H1-716	1-7/16"	C	2.1" (53.5)	1.73" (44)	0.74" (19)	2.24" (57)
S66H1-12	1-1/2"	C	2.2" (56)	1.73" (44)	0.86" (22)	2.24" (57)
S66H1-916	1-9/16"	C	2.3" (58.5)	1.73" (44)	0.86" (22)	2.28" (58)
S66H1-58	1-5/8"	C	2.36" (60)	1.73" (44)	0.86" (22)	2.28" (58)
S66H1-1116	1-11/16"	C	2.5" (63.5)	1.73" (44)	1.02" (26)	2.44" (62)
S66H1-34	1-3/4"	C	2.53" (64.5)	1.73" (44)	1.02" (26)	2.44" (62)
S66H1-1316	1-13/16"	C	2.59" (66)	1.73" (44)	1.02" (26)	2.44" (62)
S66H1-78	1-7/8"	C	2.67" (68)	1.73" (44)	1.06" (27)	2.67" (68)
S66H1-1516	1-15/16"	C	2.75" (70)	1.73" (44)	1.06" (27)	2.67" (68)
S66H2	2"	C	2.79" (71)	1.73" (44)	1.06" (27)	2.67" (68)
S66H2-116	2-1/16"	C	2.91" (74)	2.12" (54)	1.22" (31)	2.79" (71)
SS6H2-18	2-1/8"	C	2.99" (76)	2.12" (54)	1.22" (31)	2.79" (71)
S66H2-316	2-3/16"	C	3.07" (78)	2.12" (54)	1.22" (31)	2.79" (71)
S66H2-14	2-1/4"	C	3.15" (80)	2.12" (54)	1.29" (33)	2.87" (73)
S66H2-516	2-5/16"	C	3.2" (81.5)	2.12" (54)	1.29" (33)	2.87" (73)
S66H2-38	2-3/8"	C	3.28" (83.5)	2.12" (54)	1.33" (34)	2.87" (73)
S66H2-716	2-7/16"	C	3.34" (85)	2.12" (54)	1.33" (34)	2.95" (75)
S66H2-12	2-1/2"	C	3.4" (86.5)	2.12" (54)	1.33" (34)	2.95" (75)

Part Number	Output Size	Type	D1 in (mm)	D2 in (mm)	T in (mm)	L in (mm)
METRIC (mm)						
S66M17	17	A	1.18 (30)	1.73 (44)	0.51 (13)	2 (51)
S66M18	18	A	1.22 (31)	1.73 (44)	0.51 (13)	2 (51)
S66M19	19	A	1.28 (32.5)	1.73 (44)	0.51 (13)	2 (51)
S66M20	20	A	1.31 (33.5)	1.73 (44)	0.51 (13)	2 (51)
S66M21	21	A	1.37 (35)	1.73 (44)	0.51 (13)	2 (51)
S66M22	22	A	1.41 (36)	1.73 (44)	0.51 (13)	2 (51)
S66M23	23	A	1.47 (37.5)	1.73 (44)	0.51 (13)	2 (51)
S66M24	24	A	1.51 (38.5)	1.73 (44)	0.63 (16)	2 (51)
S66M25	25	A	1.57 (40)	1.73 (44)	0.63 (16)	2.08 (53)
S66M26	26	A	1.61 (41)	1.73 (44)	0.63 (16)	2.08 (53)
S66M27	27	A	1.67 (42.5)	1.73 (44)	0.63 (16)	2.08 (53)
S66M28	28	B	1.73 (44)	1.73 (44)	0.74 (19)	2.08 (53)
S66M29	29	C	1.77 (45)	1.73 (44)	0.74 (19)	2.08 (53)
S66M30	30	C	1.81 (46)	1.73 (44)	0.74 (19)	2.08 (53)
S66M31	31	C	1.87 (47.5)	1.73 (44)	0.74 (19)	2.24 (57)
S66M32	32	C	1.9 (48.5)	1.73 (44)	0.74 (19)	2.24 (57)
S66M33	33	C	1.96 (50)	1.73 (44)	0.86 (22)	2.24 (57)
S66M34	34	C	2 (51)	1.73 (44)	0.86 (22)	2.24 (57)
S66M35	35	C	2.06 (52.5)	1.73 (44)	0.86 (22)	2.24 (57)
S66M36	36	C	2.1 (53.5)	1.73 (44)	0.86 (22)	2.24 (57)
S66M37	37	C	2.16 (55)	1.73 (44)	0.86 (22)	2.24 (57)
S66M38	38	C	2.2 (56)	1.73 (44)	0.86 (22)	2.24 (57)
S66M40	40	C	2.3 (58.5)	1.73 (44)	0.86 (22)	2.28 (58)
S66M41	41	C	2.36 (60)	1.73 (44)	0.86 (22)	2.28 (58)
S66M42	42	C	2.4 (61)	1.73 (44)	0.98 (25)	2.28 (58)
S66M43	43	C	2.46 (62.5)	1.73 (44)	0.98 (25)	2.44 (62)
S66M44	44	C	2.52 (64)	1.73 (44)	0.98 (25)	2.44 (62)
S66M46	46	C	2.59 (66)	1.73 (44)	0.98 (25)	2.44 (62)
S66M50	50	C	2.79 (71)	1.73 (44)	1.18 (30)	2.67 (68)



3/4" Square Drive Sockets

Deep

Part Number	Output Size	Type	D1 in (mm)	D2 in (mm)	T in (mm)	L in (mm)
SAE (in)						
S66H12L	1/2"	A	0.9" (23)	1.63" (41.4)	0.63" (16)	3.54" (90)
S66H916L	9/16"	A	1" (25.5)	1.63" (41.4)	0.63" (16)	3.54" (90)
S66H58L	5/8"	A	1.1" (28)	1.63" (41.4)	0.63" (16)	3.54" (90)
S66H1116L	11/16"	A	1.16" (29.5)	1.63" (41.4)	0.63" (16)	3.54" (90)
S66H34L	3/4"	A	1.26" (32)	1.63" (41.4)	0.63" (16)	3.54" (90)
S66H1316L	13/16"	A	1.37" (35)	1.63" (41.4)	0.63" (16)	3.54" (90)
S66H78L	7/8"	A	1.41" (36)	1.63" (41.4)	0.63" (16)	3.54" (90)
S66H1516L	15/16"	A	1.51" (38.5)	1.63" (41.4)	0.63" (16)	3.54" (90)
S66H1L	1"	A	1.57" (40)	1.63" (41.4)	0.63" (16)	3.54" (90)
S66H1-116L	1-1/16"	A	1.67" (42.5)	1.73" (44)	0.63" (16)	3.54" (90)
S66H1-18L	1-1/8"	B	1.73" (44)	1.73" (44)	0.63" (16)	3.54" (90)
S66H1-316L	1-3/16"	C	1.81" (46)	1.73" (44)	0.63" (16)	3.54" (90)
S66H1-14L	1-1/4"	C	1.9" (48.5)	1.73" (44)	0.63" (16)	3.54" (90)
S66H1-516L	1-5/16"	C	1.96" (50)	1.73" (44)	0.86" (22)	3.54" (90)
S66H1-38L	1-3/8"	C	2.06" (52.5)	1.73" (44)	0.86" (22)	3.54" (90)
S66H1-716L	1-7/16"	C	2.1" (53.5)	1.73" (44)	0.86" (22)	3.54" (90)
S66H1-12L	1-1/2"	C	2.2" (56)	1.73" (44)	0.86" (22)	3.54" (90)
S66H1-916L	1-9/16"	C	2.3" (58.5)	1.73" (44)	0.86" (22)	3.54" (90)
S66H1-58L	1-5/8"	C	2.36" (60)	1.73" (44)	0.86" (22)	3.54" (90)
S66H1-1116L	1-11/16"	C	2.5" (63.5)	1.73" (44)	1.06" (27)	3.54" (90)
S66H1-34L	1-3/4"	C	2.53" (64.5)	1.73" (44)	1.06" (27)	3.54" (90)
S66H1-1316L	1-13/16"	C	2.59" (66)	1.73" (44)	1.06" (27)	3.54" (90)
S66H1-78L	1-7/8"	C	2.67" (68)	1.73" (44)	1.06" (27)	3.54" (90)
S66H1-1516L	1-15/16"	C	2.75" (70)	1.73" (44)	1.06" (27)	3.54" (90)
S66H2L	2"	C	2.79" (71)	1.73" (44)	1.06" (27)	3.54" (90)
S66H2-116L	2-1/16"	C	2.91" (74)	2.12" (54)	1.22" (31)	3.93" (100)
S66H2-18L	2-1/8"	C	2.99" (76)	2.12" (54)	1.22" (31)	3.93" (100)
S66H2-316L	2-3/16"	C	3.07" (78)	2.12" (54)	1.22" (31)	3.93" (100)
S66H2-14L	2-1/4"	C	3.15" (80)	2.12" (54)	1.33" (34)	3.93" (100)
S66H2-516L	2-5/16"	C	3.2" (81.5)	2.12" (54)	1.33" (34)	4.13" (105)
S66H2-38L	2-3/8"	C	3.28" (83.5)	2.12" (54)	1.33" (34)	4.13" (105)
S66H2-716L	2-7/16"	C	3.34" (85)	2.12" (54)	1.33" (34)	4.13" (105)
S66H2-12L	2-1/2"	C	3.38" (86)	2.12" (54)	1.33" (34)	4.13" (105)

Part Number	Output Size	Type	D1 in (mm)	D2 in (mm)	T in (mm)	L in (mm)
METRIC (mm)						
S66M17L	17	A	1.18 (30)	1.73 (44)	0.74 (19)	3.54 (90)
S66M19L	19	A	1.28 (32.5)	1.73 (44)	0.74 (19)	3.54 (90)
S66M20L	20	A	1.31 (33.5)	1.73 (44)	0.74 (19)	3.54 (90)
S66M21L	21	A	1.37 (35)	1.73 (44)	0.74 (19)	3.54 (90)
S66M22L	22	A	1.41 (36)	1.73 (44)	0.74 (19)	3.54 (90)
S66M23L	23	A	1.47 (37.5)	1.73 (44)	0.74 (19)	3.54 (90)
S66M24L	24	A	1.51 (38.5)	1.73 (44)	0.74 (19)	3.54 (90)
S66M25L	25	A	1.57 (40)	1.73 (44)	0.74 (19)	3.54 (90)
S66M26L	26	A	1.61 (41)	1.73 (44)	0.86 (22)	3.54 (90)
S66M27L	27	A	1.67 (42.5)	1.73 (44)	0.86 (22)	3.54 (90)
S66M28L	28	B	1.73 (44)	1.73 (44)	0.86 (22)	3.54 (90)
S66M29L	29	C	1.77 (45)	1.73 (44)	0.86 (22)	3.54 (90)
S66M30L	30	C	1.81 (46)	1.73 (44)	0.86 (22)	3.54 (90)
S66M31L	31	C	1.87 (47.5)	1.73 (44)	0.86 (22)	3.54 (90)
S66M32L	32	C	1.9 (48.5)	1.73 (44)	0.86 (22)	3.54 (90)
S66M33L	33	C	1.96 (50)	1.73 (44)	0.98 (25)	3.54 (90)
S66M34L	34	C	2 (51)	1.73 (44)	0.98 (25)	3.54 (90)
S66M35L	35	C	2.06 (52.5)	1.73 (44)	0.98 (25)	3.54 (90)
S66M36L	36	C	2.1 (53.5)	1.73 (44)	0.98 (25)	3.54 (90)
S66M38L	38	C	2.2 (56)	1.73 (44)	0.98 (25)	3.54 (90)
S66M40L	40	C	2.3 (58.5)	1.73 (44)	1.18 (30)	3.54 (90)
S66M41L	41	C	2.36 (60)	1.73 (44)	1.18 (30)	3.54 (90)
S66M42L	42	C	2.4 (61)	1.73 (44)	1.18 (30)	3.54 (90)
S66M43L	43	C	2.46 (62.5)	1.73 (44)	1.18 (30)	3.54 (90)
S66M44L	44	C	2.52 (64)	1.73 (44)	1.18 (30)	3.54 (90)
S66M46L	46	C	2.59 (66)	1.73 (44)	1.18 (30)	3.54 (90)
S66M50L	50	C	2.79 (71)	1.73 (44)	1.18 (30)	3.54 (90)



3/4" Square Drive Sockets

Universal

Part Number	Output Size	Type	D1 in (mm)	D2 in (mm)	T in (mm)	L in (mm)
SAE (in)						
S66H1116U	11/16"	A	1.14" (29)	1.73" (44)	0.51" (13)	3.74" (95)
S66H34U	3/4"	A	1.26" (32)	1.73" (44)	0.51" (13)	3.74" (95)
S66H1316U	13/16"	A	1.37" (35)	1.73" (44)	0.51" (13)	3.74" (95)
S66H78U	7/8"	A	1.45" (37)	1.73" (44)	0.51" (13)	3.74" (95)
S66H1516U	15/16"	A	1.53" (39)	1.73" (44)	0.51" (13)	3.74" (95)
S66H1U	1"	A	1.61" (41)	1.73" (44)	0.51" (13)	3.93" (100)
S66H1-116U	1-1/16"	A	1.69" (43)	1.73" (44)	0.66" (17)	3.93" (100)
S66H1-18U	1-1/8"	A	1.73" (44)	1.73" (44)	0.66" (17)	3.93" (100)
S66H1-316U	1-3/16"	A	1.85" (47)	1.73" (44)	0.66" (17)	3.93" (100)
S66H1-14U	1-1/4"	A	1.92" (49)	1.73" (44)	0.66" (17)	4.13" (105)
S66H1-516U	1-5/16"	A	2" (51)	1.73" (44)	0.74" (19)	4.13" (105)
S66H1-38U	1-3/8"	A	2.08" (53)	1.73" (44)	0.74" (19)	4.13" (105)
S66H1-716U	1-7/16"	A	2.12" (54)	1.73" (44)	0.74" (19)	4.33" (110)
S66H1-12U	1-1/2"	A	2.24" (57)	1.73" (44)	0.86" (22)	4.33" (110)
S66H1-916U	1-9/16"	A	2.36" (60)	1.73" (44)	0.86" (22)	4.33" (110)
S66H1-58U	1-5/8"	A	2.36" (60)	1.73" (44)	0.86" (22)	4.52" (115)
S66H1-1116U	1-11/16"	A	2.48" (63)	1.73" (44)	1.06" (27)	4.52" (115)
S66H1-34U	1-3/4"	A	2.52" (64)	1.73" (44)	1.06" (27)	4.52" (115)
S66H1-1316U	1-13/16"	A	2.59" (66)	1.73" (44)	1.06" (27)	4.52" (115)
S66H1-78U	1-7/8"	A	2.67" (68)	1.73" (44)	1.06" (27)	4.52" (115)



Adapters

Part Number	Output Drive Size	Description
A6F4M	1/2"	3/4" F to 1/2" M
A6F8M	1"	3/4" F to 1" M
A6FS5M	#5 spline	3/4" F to #5 spline M
J6	3/4"	Universal joint



Part Number	Output Size	Type	D1 in (mm)	D2 in (mm)	T in (mm)	L in (mm)
METRIC (mm)						
S66M17U	17	A	1.14 (29)	1.73 (44)	0.47 (12)	3.74 (95)
S66M19U	19	A	1.26 (32)	1.73 (44)	0.47 (12)	3.74 (95)
S66M20U	20	A	1.33 (34)	1.73 (44)	0.47 (12)	3.74 (95)
S66M21U	21	A	1.37 (35)	1.73 (44)	0.47 (12)	3.74 (95)
S66M22U	22	A	1.45 (37)	1.73 (44)	0.55 (14)	3.74 (95)
S66M23U	23	A	1.49 (38)	1.73 (44)	0.55 (14)	3.74 (95)
S66M24U	24	A	1.53 (39)	1.73 (44)	0.55 (14)	3.74 (95)
S66M25U	25	A	1.61 (41)	1.73 (44)	0.55 (14)	3.93 (100)
S66M26U	26	A	1.65 (42)	1.73 (44)	0.66 (17)	3.93 (100)
S66M27U	27	A	1.69 (43)	1.73 (44)	0.66 (17)	3.93 (100)
S66M28U	28	A	1.73 (44)	1.73 (44)	0.66 (17)	3.93 (100)
S66M29U	29	A	1.81 (46)	1.73 (44)	0.66 (17)	3.93 (100)
S66M30U	30	A	1.85 (47)	1.73 (44)	0.66 (17)	3.93 (100)
S66M31U	31	A	1.89 (48)	1.73 (44)	0.82 (21)	4.13 (105)
S66M32U	32	A	1.92 (49)	1.73 (44)	0.82 (21)	4.13 (105)
S66M33U	33	A	2 (51)	1.73 (44)	0.82 (21)	4.13 (105)
S66M34U	34	A	2.04 (52)	1.73 (44)	0.82 (21)	4.13 (105)
S66M35U	35	A	2.08 (53)	1.73 (44)	0.82 (21)	4.13 (105)
S66M36U	36	A	2.12 (54)	1.73 (44)	0.9 (23)	4.33 (110)
S66M37U	37	A	2.2 (56)	1.73 (44)	0.9 (23)	4.33 (110)
S66M38U	38	A	2.24 (57)	1.73 (44)	0.9 (23)	4.33 (110)
S66M39U	39	A	2.32 (59)	1.73 (44)	0.9 (23)	4.33 (110)
S66M40U	40	A	2.36 (60)	1.73 (44)	0.9 (23)	4.33 (110)
S66M41U	41	A	2.36 (60)	1.73 (44)	1.02 (26)	4.52 (115)
S66M42U	42	A	2.44 (62)	1.73 (44)	1.02 (26)	4.52 (115)
S66M43U	43	A	2.48 (63)	1.73 (44)	1.02 (26)	4.52 (115)
S66M44U	44	A	2.52 (64)	1.73 (44)	1.14 (29)	4.52 (115)
S66M45U	45	A	2.59 (66)	1.73 (44)	1.14 (29)	4.52 (115)
S66M46U	46	A	2.59 (66)	1.73 (44)	1.14 (29)	4.52 (115)

Extensions

Part Number	Output Drive Size	Description
E63H	3/4"	3" extension
E67H	3/4"	7" extension
E610H	3/4"	10" extension
E613H	3/4"	13" extra-long extension



1" Square Drive Sockets

Sets

Part Number	Pieces	Description	Contents
SK8H8	8	1" drive SAE standard socket set	7/8", 15/16", 1", 1-1/16", 1-1/8", 1-3/16", 1-1/4", 1-1/2"
SK8H8L	8	1" drive SAE deep socket set	7/8", 15/16", 1", 1-1/16", 1-1/8", 1-3/16", 1-1/4", 1-1/2"
SK8H9T	9	1" drive SAE truck service socket set	13/16" square; 7/8", 15/16", 1", 1-3/16", 1-1/2" hex; 1-1/16", 1-1/8", 1-1/4" deep thin wall hex
SK8C5T	5	1" drive combo SAE and metric deep truck service socket set	13/16" square; 33 mm & 1-1/2" deep hex; 1-1/8" and 1-1/4" deep thin wall hex
SK8M4L	4	1" drive metric deep socket set	27 mm, 30 mm, 32 mm, 33 mm



SK8H8



SK8H8L



SK8H9T



SK8C5T



SK8M4L

1" Square Drive Sockets

Standard

Part Number	Output Size	Type	D1 in (mm)	D2 in (mm)	T in (mm)	L in (mm)
SAE (in)						
S68H34	3/4"	A	1.37" (35)	2.12" (54)	0.66" (17)	2.28" (58)
S68H1316	13/16"	A	1.47" (37.5)	2.12" (54)	0.66" (17)	2.28" (58)
S68H78	7/8"	A	1.53" (39)	2.12" (54)	0.66" (17)	2.28" (58)
S68H1516	15/16"	A	1.59" (40.5)	2.12" (54)	0.66" (17)	2.28" (58)
S68H1	1"	A	1.67" (42.5)	2.12" (54)	0.66" (17)	2.36" (60)
S68H1-116	1-1/16"	A	1.75" (44.5)	2.12" (54)	0.66" (17)	2.36" (60)
S68H1-18	1-1/8"	A	1.81" (46)	2.12" (54)	0.66" (17)	2.44" (62)
S68H1-316	1-3/16"	A	1.92" (49)	2.12" (54)	0.66" (17)	2.44" (62)
S68H1-14	1-1/4"	B	2.02" (51.5)	2.12" (54)	0.66" (17)	2.48" (63)
S68H1-516	1-5/16"	C	2.12" (54)	2.12" (54)	0.74" (19)	2.48" (63)
S68H1-38	1-3/8"	C	2.16" (55)	2.12" (54)	0.74" (19)	2.59" (66)
S68H1-716	1-7/16"	C	2.22" (56.5)	2.12" (54)	0.74" (19)	2.59" (66)
S68H1-12	1-1/2"	C	2.32" (59)	2.12" (54)	0.86" (22)	2.59" (66)
S68H1-916	1-9/16"	C	2.4" (61)	2.12" (54)	0.86" (22)	2.59" (66)
S68H1-58	1-5/8"	C	2.46" (62.5)	2.12" (54)	0.86" (22)	2.67" (68)
S68H1-1116	1-11/16"	C	2.55" (65)	2.12" (54)	0.98" (25)	2.75" (70)
S68H1-34	1-3/4"	C	2.65" (67.5)	2.37" (60.3)	0.98" (25)	2.75" (70)
S68H1-1316	1-13/16"	C	2.71" (69)	2.37" (60.3)	1.06" (27)	2.83" (72)
S68H1-78	1-7/8"	C	2.75" (70)	2.37" (60.3)	1.06" (27)	2.83" (72)
S68H1-1516	1-15/16"	C	2.85" (72.5)	2.37" (60.3)	1.06" (27)	2.99" (76)

Part Number	Output Size	Type	D1 in (mm)	D2 in (mm)	T in (mm)	L in (mm)
METRIC (mm)						
S68M19	19	A	1.37 (35)	2.12 (54)	0.66 (17)	2.28 (58)
S68M21	21	A	1.47 (37.5)	2.12 (54)	0.66 (17)	2.28 (58)
S68M22	22	A	1.53 (39)	2.12 (54)	0.66 (17)	2.28 (58)
S68M23	23	A	1.57 (40)	2.12 (54)	0.66 (17)	2.28 (58)
S68M24	24	A	1.63 (41.5)	2.12 (54)	0.66 (17)	2.28 (58)
S68M25	25	A	1.67 (42.5)	2.12 (54)	0.66 (17)	2.36 (60)
S68M26	26	A	1.73 (44)	2.12 (54)	0.66 (17)	2.36 (60)
S68M27	27	A	1.77 (45)	2.12 (54)	0.66 (17)	2.36 (60)
S68M28	28	A	1.83 (46.5)	2.12 (54)	0.66 (17)	2.36 (60)
S68M29	29	A	1.87 (47.5)	2.12 (54)	0.74 (19)	2.44 (62)
S68M30	30	A	1.92 (49)	2.12 (54)	0.74 (19)	2.44 (62)
S68M31	31	A	1.96 (50)	2.12 (54)	0.74 (19)	2.44 (62)
S68M32	32	A	2.02 (51.5)	2.12 (54)	0.74 (19)	2.48 (63)
S68M33	33	A	2.06 (52.5)	2.12 (54)	0.82 (21)	2.48 (63)
S68M34	34	B	2.12 (54)	2.12 (54)	0.82 (21)	2.48 (63)
S68M35	35	C	2.16 (55)	2.12 (54)	0.82 (21)	2.59 (66)
S68M36	36	C	2.22 (56.5)	2.12 (54)	0.9 (23)	2.59 (66)
S68M38	38	C	2.32 (59)	2.12 (54)	0.9 (23)	2.59 (66)
S68M40	40	C	2.4 (61)	2.12 (54)	0.9 (23)	2.59 (66)
S68M41	41	C	2.46 (62.5)	2.12 (54)	0.98 (25)	2.67 (68)

1" Square Drive Sockets

Standard

Part Number	Output Size	Type	D1 in (mm)	D2 in (mm)	T in (mm)	L in (mm)
SAE (in)						
S68H2	2"	C	2.91" (74)	2.37" (60.3)	1.06" (27)	2.99" (76)
S68H2-116	2-1/16"	C	3.01" (76.5)	2.37" (60.3)	1.22" (31)	3.15" (80)
S68H2-18	2-1/8"	C	3.11" (79)	2.37" (60.3)	1.22" (31)	3.15" (80)
S68H2-316	2-3/16"	C	3.15" (80)	2.37" (60.3)	1.22" (31)	3.3" (84)
S68H2-14	2-1/4"	C	3.24" (82.5)	2.37" (60.3)	1.33" (34)	3.3" (84)
S68H2-516	2-5/16"	C	3.3" (84)	2.37" (60.3)	1.33" (34)	3.3" (84)
S68H2-38	2-3/8"	C	3.4" (86.5)	2.37" (60.3)	1.33" (34)	3.46" (88)
S68H2-716	2-7/16"	C	3.5" (89)	2.37" (60.3)	1.41" (36)	3.46" (88)
S68H2-12	2-1/2"	C	3.6" (91.5)	2.37" (60.3)	1.41" (36)	3.46" (88)
S68H2-916	2-9/16"	C	3.64" (92.5)	2.37" (60.3)	1.41" (36)	3.62" (92)
S68H2-58	2-5/8"	C	3.74" (95)	2.37" (60.3)	1.49" (38)	3.62" (92)
S68H2-1116	2-11/16"	C	3.79" (96.5)	2.37" (60.3)	1.49" (38)	3.78" (96)
S68H2-34	2-3/4"	C	3.89" (99)	2.37" (60.3)	1.49" (38)	3.78" (96)
S68H2-1316	2-13/16"	C	3.99" (101.5)	2.37" (60.3)	1.61" (41)	3.78" (96)
S68H2-78	2-7/8"	C	4.03" (102.5)	2.37" (60.3)	1.61" (41)	3.78" (96)
S68H2-1516	2-15/16"	C	4.11" (104.5)	2.37" (60.3)	1.61" (41)	3.93" (100)
S68H3	3"	C	4.19" (106.5)	2.37" (60.3)	1.73" (44)	3.93" (100)
S68H3-18	3-1/8"	C	4.37" (111)	2.37" (60.3)	1.73" (44)	3.93" (100)
S68H3-14	3-1/4"	C	4.52" (115)	3.38" (86)	1.73" (44)	4.01" (102)
S68H3-38	3-3/8"	C	4.68" (119)	3.38" (86)	1.92" (49)	4.17" (106)
S68H3-12	3-1/2"	C	4.88" (124)	3.38" (86)	1.92" (49)	4.25" (108)
S68H3-58	3-5/8"	C	5" (127)	3.38" (86)	2.08" (53)	4.33" (110)
S68H3-34	3-3/4"	C	5.11" (130)	3.38" (86)	2.08" (53)	4.33" (110)
S68H3-78	3-7/8"	C	5.35" (136)	3.74" (95)	2.2" (56)	4.52" (115)
S68H4	4"	C	5.51" (140)	3.74" (95)	2.2" (56)	4.52" (115)
S68H4-18	4-1/8"	C	5.63" (143)	3.74" (95)	2.32" (59)	4.72" (120)

Deep

Part Number	Output Size	Type	D1 in (mm)	D2 in (mm)	T in (mm)	L in (mm)
SAE (in)						
S68H34L	3/4"	A	1.37" (35)	2.12" (54)	0.98" (25)	3.54" (90)
S68H1316L	13/16"	A	1.45" (37)	2.12" (54)	0.98" (25)	3.54" (90)
S68H78L	7/8"	A	1.53" (39)	2.12" (54)	0.98" (25)	3.54" (90)
S68H1516L	15/16"	A	1.59" (40.5)	2.12" (54)	0.98" (25)	3.54" (90)
S68H1L	1"	A	1.67" (42.5)	2.12" (54)	0.98" (25)	3.54" (90)
S68H1-116L	1-1/16"	A	1.75" (44.5)	2.12" (54)	0.98" (25)	3.54" (90)
S68H1-18L	1-1/8"	A	1.81" (46)	2.12" (54)	0.98" (25)	3.54" (90)

Part Number	Output Size	Type	D1 in (mm)	D2 in (mm)	T in (mm)	L in (mm)
SAE (in)						
S68H4-14	4-1/4"	C	5.74" (146)	3.74" (95)	2.32" (59)	4.72" (120)
S68H4-38	4-3/8"	C	5.86" (149)	3.74" (95)	2.4" (61)	4.72" (120)
S68H4-12	4-1/2"	C	5.98" (152)	3.74" (95)	2.4" (61)	4.72" (120)
METRIC (mm)						
S68M42	42	C	2.52 (64)	2.12 (54)	0.98 (25)	2.67 (68)
S68M43	43	C	2.55 (65)	2.12 (54)	0.98 (25)	2.75 (70)
S68M45	45	C	2.65 (67.5)	2.12 (54)	0.98 (25)	2.75 (70)
S68M46	46	C	2.71 (69)	2.12 (54)	1.14 (29)	2.83 (72)
S68M48	48	C	2.81 (71.5)	2.12 (54)	1.14 (29)	2.99 (76)
S68M50	50	C	2.91 (74)	2.12 (54)	1.22 (31)	2.99 (76)
S68M52	52	C	3.01 (76.5)	2.12 (54)	1.22 (31)	3.15 (80)
S68M54	54	C	3.11 (79)	2.12 (54)	1.22 (31)	3.15 (80)
S68M55	55	C	3.15 (80)	2.12 (54)	1.33 (34)	3.3 (84)
S68M56	56	C	3.2 (81.5)	2.12 (54)	1.33 (34)	3.3 (84)
S68M58	58	C	3.3 (84)	2.12 (54)	1.33 (34)	3.3 (84)
S68M60	60	C	3.4 (86.5)	2.12 (54)	1.37 (35)	3.46 (88)
S68M65	65	C	3.64 (92.5)	2.12 (54)	1.37 (35)	3.62 (92)
S68M70	70	C	3.89 (99)	2.12 (54)	1.37 (35)	3.78 (96)
S68M75	75	C	4.13 (105)	2.37 (60.3)	1.37 (35)	4.01 (102)
S68M80	80	C	4.39 (111.5)	2.37 (60.3)	1.37 (35)	4.01 (102)
S68M85	85	C	4.62 (117.5)	3.38 (86)	1.37 (35)	4.17 (106)
S68M90	90	C	4.88 (124)	3.38 (86)	1.37 (35)	4.25 (108)
S68M95	95	C	5.11 (130)	3.38 (86)	1.37 (35)	4.33 (110)



1" Square Drive Sockets

Deep

Part Number	Output Size	Type	D1 in (mm)	D2 in (mm)	T in (mm)	L in (mm)
SAE (in)						
S68H1-316L	1-3/16"	A	1.92" (49)	2.12" (54)	0.98" (25)	3.54" (90)
S68H1-14L	1-1/4"	A	2.02" (51.5)	2.12" (54)	0.98" (25)	3.54" (90)
S68H1-516L	1-5/16"	B	2.12" (54)	2.12" (54)	0.98" (25)	3.54" (90)
S68H1-38L	1-3/8"	C	2.16" (55)	2.12" (54)	0.98" (25)	3.54" (90)
S68H1-716L	1-7/16"	C	2.22" (56.5)	2.12" (54)	0.98" (25)	3.54" (90)
S68H1-12L	1-1/2"	C	2.32" (59)	2.12" (54)	0.98" (25)	3.54" (90)
S68H1-916L	1-9/16"	C	2.4" (61)	2.12" (54)	0.98" (25)	3.54" (90)
S68H1-58L	1-5/8"	C	2.46" (62.5)	2.12" (54)	0.98" (25)	3.54" (90)
S68H1-1116L	1-11/16"	C	2.55" (65)	2.12" (54)	0.98" (25)	3.54" (90)
S68H1-34L	1-3/4"	C	2.65" (67.5)	2.37" (60.3)	1.22" (31)	3.93" (100)
S68H1-1316L	1-13/16"	C	2.71" (69)	2.37" (60.3)	1.22" (31)	3.93" (100)
S68H1-78L	1-7/8"	C	2.75" (70)	2.37" (60.3)	1.22" (31)	3.93" (100)
S68H1-1516L	1-15/16"	C	2.85" (72.5)	2.37" (60.3)	1.22" (31)	3.93" (100)
S68H2L	2"	C	2.91" (74)	2.37" (60.3)	1.22" (31)	3.93" (100)
S68H2-116L	2-1/16"	C	3.01" (76.5)	2.37" (60.3)	1.22" (31)	3.93" (100)
S68H2-18L	2-1/8"	C	3.11" (79)	2.37" (60.3)	1.22" (31)	4.25" (108)
S68H2-316L	2-3/16"	C	3.15" (80)	2.37" (60.3)	1.22" (31)	4.25" (108)
S68H2-14L	2-1/4"	C	3.24" (82.5)	2.37" (60.3)	1.41" (36)	4.25" (108)
S68H2-516L	2-5/16"	C	3.3" (84)	2.37" (60.3)	1.41" (36)	4.25" (108)
S68H2-38L	2-3/8"	C	3.4" (86.5)	2.37" (60.3)	1.41" (36)	4.25" (108)
S68H2-716L	2-7/16"	C	3.5" (89)	2.37" (60.3)	1.41" (36)	4.25" (108)
S68H2-12L	2-1/2"	C	3.6" (91.5)	2.37" (60.3)	1.41" (36)	4.72" (120)
S68H2-916L	2-9/16"	C	3.64" (92.5)	2.37" (60.3)	1.41" (36)	4.72" (120)
S68H2-58L	2-5/8"	C	3.74" (95)	2.37" (60.3)	1.73" (44)	4.72" (120)
S68H2-1116L	2-11/16"	C	3.79" (96.5)	2.37" (60.3)	1.73" (44)	4.72" (120)
S68H2-34L	2-3/4"	C	3.89" (99)	2.37" (60.3)	1.73" (44)	4.92" (125)
S68H2-1316L	2-13/16"	C	3.99" (101.5)	2.37" (60.3)	1.73" (44)	4.92" (125)
S68H2-78L	2-7/8"	C	4.03" (102.5)	2.37" (60.3)	1.73" (44)	4.92" (125)
S68H2-1516L	2-15/16"	C	4.11" (104.5)	2.37" (60.3)	1.73" (44)	4.92" (125)
S68H3L	3"	C	4.19" (106.5)	2.37" (60.3)	1.73" (44)	4.92" (125)
S68H3-18L	3-1/8"	C	4.39" (111.5)	2.37" (60.3)	1.73" (44)	4.92" (125)
S68H3-14L	3-1/4"	C	4.44" (113)	3.38" (86)	1.73" (44)	5.31" (135)
S68H3-38L	3-3/8"	C	4.52" (115)	3.38" (86)	2.2" (56)	5.31" (135)
S68H3-12L	3-1/2"	C	4.68" (119)	3.38" (86)	2.2" (56)	5.31" (135)
S68H3-58L	3-5/8"	C	5" (127)	3.38" (86)	2.2" (56)	5.51" (140)
S68H3-34L	3-3/4"	C	5.11" (130)	3.38" (86)	2.2" (56)	5.51" (140)
S68H3-78L	3-7/8"	C	5.35" (136)	3.74" (95)	2.2" (56)	5.51" (140)
S68H4L	4"	C	5.51" (140)	3.74" (95)	2.2" (56)	6.1" (155)

Part Number	Output Size	Type	D1 in (mm)	D2 in (mm)	T in (mm)	L in (mm)
SAE (in)						
S68H4-18L	4-1/8"	C	5.63" (143)	3.74" (95)	2.4" (61)	6.1" (155)
S68H4-14L	4-1/4"	C	5.74" (146)	3.74" (95)	2.4" (61)	6.1" (155)
S68H4-38L	4-3/8"	C	5.86" (149)	3.74" (95)	2.4" (61)	6.1" (155)
S68H4-12L	4-1/2"	C	5.98" (152)	3.74" (95)	2.4" (61)	6.1" (155)
METRIC (mm)						
S68M27L	27	A	1.77 (45)	2.12 (54)	0.98 (25)	3.54 (90)
S68M28L	28	A	1.83 (46.5)	2.12 (54)	0.98 (25)	3.54 (90)
S68M29L	29	A	1.87 (47.5)	2.12 (54)	0.98 (25)	3.54 (90)
S68M30L	30	A	1.92 (49)	2.12 (54)	0.98 (25)	3.54 (90)
S68M31L	31	A	1.96 (50)	2.12 (54)	0.98 (25)	3.54 (90)
S68M32L	32	A	2.02 (51.5)	2.12 (54)	0.98 (25)	3.54 (90)
S68M33L	33	A	2.06 (52.5)	2.12 (54)	0.98 (25)	3.54 (90)
S68M34L	34	B	2.12 (54)	2.12 (54)	0.98 (25)	3.54 (90)
S68M35L	35	C	2.16 (55)	2.12 (54)	0.98 (25)	3.54 (90)
S68M36L	36	C	2.22 (56.5)	2.12 (54)	0.98 (25)	3.54 (90)
S68M37L	37	C	2.28 (58)	2.12 (54)	0.98 (25)	3.54 (90)
S68M38L	38	C	2.32 (59)	2.12 (54)	0.98 (25)	3.54 (90)
S68M40L	40	C	2.4 (61)	2.12 (54)	0.98 (25)	3.54 (90)
S68M41L	41	C	2.46 (62.5)	2.12 (54)	0.98 (25)	3.54 (90)
S68M42L	42	C	2.52 (64)	2.12 (54)	0.98 (25)	3.54 (90)
S68M43L	43	C	2.55 (65)	2.12 (54)	0.98 (25)	3.54 (90)
S68M45L	45	C	2.65 (67.5)	2.12 (54)	1.18 (30)	3.93 (100)
S68M46L	46	C	2.71 (69)	2.12 (54)	1.18 (30)	3.93 (100)
S68M48L	48	C	2.81 (71.5)	2.12 (54)	1.18 (30)	3.93 (100)
S68M50L	50	C	2.91 (74)	2.12 (54)	1.18 (30)	3.93 (100)
S68M52L	52	C	3.01 (76.5)	2.12 (54)	1.18 (30)	3.93 (100)
S68M54L	54	C	3.11 (79)	2.12 (54)	1.37 (35)	4.25 (108)
S68M55L	55	C	3.15 (80)	2.12 (54)	1.37 (35)	4.25 (108)
S68M56L	56	C	3.2 (81.5)	2.12 (54)	1.37 (35)	4.25 (108)
S68M58L	58	C	3.3 (84)	2.12 (54)	1.37 (35)	4.25 (108)
S68M60L	60	C	3.4 (86.5)	2.12 (54)	1.37 (35)	4.25 (108)
S68M65L	65	C	3.64 (92.5)	2.12 (54)	1.37 (35)	4.72 (120)
S68M70L	70	C	3.89 (99)	2.12 (54)	1.37 (35)	4.92 (125)
S68M75L	75	C	4.13 (105)	2.37 (60.3)	1.37 (35)	4.92 (125)
S68M80L	80	C	4.39 (111.5)	2.37 (60.3)	1.37 (35)	4.92 (125)
S68M85L	85	C	4.52 (115)	3.38 (86)	1.37 (35)	5.31 (135)
S68M90L	90	C	4.88 (124)	3.38 (86)	1.37 (35)	5.31 (135)
S68M95L	95	C	5.11 (130)	3.38 (86)	1.37 (35)	5.51 (140)

1" Square Drive Sockets

Universal

Part Number	Output Size	Type	D1 in (mm)	D2 in (mm)	T in (mm)	L in (mm)
SAE (in)						
S68H78U	7/8"	A	1.53" (39)	2.12" (54)	0.74" (19)	5" (127)
S68H1516U	15/16"	A	1.61" (41)	2.12" (54)	0.74" (19)	5.19" (132)
S68H1-116U	1-1/16"	A	1.77" (45)	2.12" (54)	0.74" (19)	5.19" (132)
S68H1-18U	1-1/8"	A	1.89" (48)	2.12" (54)	0.74" (19)	5.19" (132)
S68H1-316U	1-3/16"	A	1.92" (49)	2.12" (54)	0.74" (19)	5.19" (132)
S68H1-14U	1-1/4"	A	2" (51)	2.12" (54)	0.74" (19)	5.19" (132)
S68H1-516U	1-5/16"	A	2.08" (53)	2.12" (54)	0.74" (19)	5.19" (132)
S68H1-38U	1-3/8"	A	2.16" (55)	2.12" (54)	0.74" (19)	5.19" (132)
S68H1-716U	1-7/16"	A	2.28" (58)	2.12" (54)	0.74" (19)	5.19" (132)
S68H1-12U	1-1/2"	A	2.32" (59)	2.12" (54)	0.98" (25)	5.39" (137)
S68H1-916U	1-9/16"	A	2.4" (61)	2.12" (54)	0.98" (25)	5.39" (137)
S68H1-58U	1-5/8"	A	2.48" (63)	2.12" (54)	0.98" (25)	5.39" (137)
S68H1-1116U	1-11/16"	A	2.55" (65)	2.12" (54)	0.98" (25)	5.39" (137)
S68H1-34U	1-3/4"	A	2.63" (67)	2.12" (54)	0.98" (25)	5.39" (137)
S68H1-1316U	1-13/16"	A	2.71" (69)	2.12" (54)	1.06" (27)	5.59" (142)
S68H1-78U	1-7/8"	A	2.79" (71)	2.12" (54)	1.06" (27)	5.59" (142)
S68H1-1516U	1-15/16"	A	2.83" (72)	2.12" (54)	1.06" (27)	5.59" (142)
S68H2U	2"	A	2.99" (76)	2.12" (54)	1.06" (27)	5.59" (142)



Adapters

Part Number	Output Drive Size	Description
A8F6M	3/4"	1" F to 3/4" M
A8F12M	1-1/2"	1" F to 1-1/2" M
A8FS5M	#5 spline	1" F to #5 spline M
J8	1"	Universal joint



Part Number	Output Size	Type	D1 in (mm)	D2 in (mm)	T in (mm)	L in (mm)
METRIC (mm)						
S68M24U	24	A	1.61 (41)	2.12 (54)	0.66 (17)	5.19 (132)
S68M26U	26	A	1.73 (44)	2.12 (54)	0.66 (17)	5.19 (132)
S68M27U	27	A	1.77 (45)	2.12 (54)	0.66 (17)	5.19 (132)
S68M29U	29	A	1.89 (48)	2.12 (54)	0.66 (17)	5.19 (132)
S68M30U	30	A	1.92 (49)	2.12 (54)	0.66 (17)	5.19 (132)
S68M32U	32	A	2 (51)	2.12 (54)	0.86 (22)	5.19 (132)
S68M33U	33	A	2.08 (53)	2.12 (54)	0.86 (22)	5.19 (132)
S68M34U	34	A	2.12 (54)	2.12 (54)	0.86 (22)	5.19 (132)
S68M35U	35	A	2.16 (55)	2.12 (54)	0.86 (22)	5.19 (132)
S68M36U	36	A	2.2 (56)	2.12 (54)	0.86 (22)	5.19 (132)
S68M38U	38	A	2.32 (59)	2.12 (54)	0.98 (25)	5.39 (137)
S68M41U	41	A	2.48 (63)	2.12 (54)	0.98 (25)	5.39 (137)
S68M42U	42	A	2.52 (64)	2.12 (54)	0.98 (25)	5.39 (137)
S68M43U	43	A	2.55 (65)	2.12 (54)	0.98 (25)	5.39 (137)
S68M44U	44	A	2.63 (67)	2.12 (54)	0.98 (25)	5.39 (137)
S68M45U	45	A	2.67 (68)	2.12 (54)	1.06 (27)	5.59 (142)
S68M46U	46	A	2.71 (69)	2.12 (54)	1.06 (27)	5.59 (142)
S68M47U	47	A	2.75 (70)	2.12 (54)	1.06 (27)	5.59 (142)
S68M48U	48	A	2.79 (71)	2.12 (54)	1.06 (27)	5.59 (142)
S68M50U	50	A	2.91 (74)	2.12 (54)	1.06 (27)	5.59 (142)

Extensions

Part Number	Output Drive Size	Description
E83H	1"	3" extension
E87H	1"	7" extension
E810H	1"	10" extension
E813H	1"	13" extra-long extension



Industrial Grade Impact Socket Displays

SD-38S (Includes Socket Rack & Header Sign)

3/8" Drive Standard Length Impact

Part Number	Output Size	Description	English, Metric, Accessory / Both	Quantity
S63H516	5/16"	Standard	E	2
S63H38	3/8"	Standard	E	2
S63H716	7/16"	Standard	E	2
S63H12	1/2"	Standard	E	2
S63H916	9/16"	Standard	E	2
S63H58	5/8"	Standard	E	2
S63H1116	11/16"	Standard	E	2
S63H34	3/4"	Standard	E	2
S63H1316	13/16"	Standard	E	2
S63H78	7/8"	Standard	E	2
S63H1516	15/16"	Standard	E	2
S63H1	1"	Standard	E	2
S63M7	7 mm	Standard	M	2
S63M8	8 mm	Standard	M	2
S63M9	9 mm	Standard	M	2
S63M10	10 mm	Standard	M	2
S63M11	11 mm	Standard	M	2
S63M12	12 mm	Standard	M	2
S63M13	13 mm	Standard	M	2
S63M14	14 mm	Standard	M	2
S63M15	15 mm	Standard	M	2
S63M16	16 mm	Standard	M	2
S63M17	17 mm	Standard	M	2
S63M18	18 mm	Standard	M	2
S63M19	19 mm	Standard	M	2
S63M20	20 mm	Standard	M	2
S63M21	21 mm	Standard	M	2
S63M22	22 mm	Standard	M	2
S63H516U	5/16"	Universal	E	2
S63H38U	3/8"	Universal	E	2
S63H716U	7/16"	Universal	E	2
S63H12U	1/2"	Universal	E	2
S63H916U	9/16"	Universal	E	2
S63H58U	5/8"	Universal	E	2
S63H1116U	11/16"	Universal	E	2
S63H34U	3/4"	Universal	E	2
S63H1316U	13/16"	Universal	E	2
S63H78U	7/8"	Universal	E	2

Part Number	Output Size	Description	English, Metric, Accessory / Both	Quantity
S63M10U	10 mm	Universal	M	2
S63M11U	11 mm	Universal	M	2
S63M12U	12 mm	Universal	M	2
S63M13U	13 mm	Universal	M	2
S63M14U	14 mm	Universal	M	2
S63M15U	15 mm	Universal	M	2
S63M16U	16 mm	Universal	M	2
S63M17U	17 mm	Universal	M	2
S63M18U	18 mm	Universal	M	2
S63M19U	19 mm	Universal	M	2
S63M20U	20 mm	Universal	M	2
S63M21U	21 mm	Universal	M	2
S63M22U	22 mm	Universal	M	2
A3F2M	1/4"	3/8" F to 1/4" M	A	2
A3F4M	1/2"	3/8" F to 1/2" M	A	2
J3	3/8"	Universal Joint	A	2

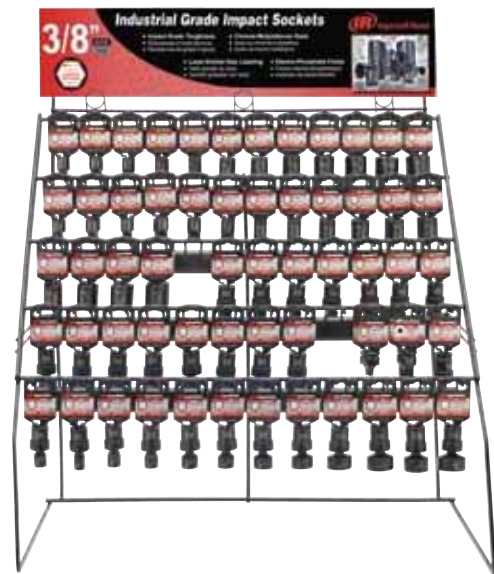

SRI Socket Rack Only
SHD-38 Header Sign Only
Dimensions
 22" High x 24" Wide x 16" Deep

Industrial Grade Impact Socket Displays

SD-38D (Includes Socket Rack & Header Sign)

3/8" Drive Deep Length Impact

Part Number	Output Size	Description	English, Metric, Accessory / Both	Quantity
S63H516L	5/16"	Deep	E	2
S63H38L	3/8"	Deep	E	2
S63H716L	7/16"	Deep	E	2
S63H12L	1/2"	Deep	E	2
S63H916L	9/16"	Deep	E	2
S63H58L	5/8"	Deep	E	2
S63H1116L	11/16"	Deep	E	2
S63H34L	3/4"	Deep	E	2
S63H1316L	13/16"	Deep	E	2
S63H78L	7/8"	Deep	E	2
S63H1516L	15/16"	Deep	E	2
S63H1L	1"	Deep	E	2
S63M7L	7 mm	Deep	M	2
S63M8L	8 mm	Deep	M	2
S63M9L	9 mm	Deep	M	2
S63M10L	10 mm	Deep	M	2
S63M11L	11 mm	Deep	M	2
S63M12L	12 mm	Deep	M	2
S63M13L	13 mm	Deep	M	2
S63M14L	14 mm	Deep	M	2
S63M15L	15 mm	Deep	M	2
S63M16L	16 mm	Deep	M	2
S63M17L	17 mm	Deep	M	2
S63M18L	18 mm	Deep	M	2
S63M19L	19 mm	Deep	M	2
S63M20L	20 mm	Deep	M	2
S63M21L	21 mm	Deep	M	2
S63M22L	22 mm	Deep	M	2
S63H516UL	5/16"	Universal Deep	E	2
S63H38UL	3/8"	Universal Deep	E	2
S63H716UL	7/16"	Universal Deep	E	2
S63H12UL	1/2"	Universal Deep	E	2
S63H916UL	9/16"	Universal Deep	E	2
S63H58UL	5/8"	Universal Deep	E	2
S63H1116UL	11/16"	Universal Deep	E	2
S63H34UL	3/4"	Universal Deep	E	2
S63H78UL	7/8"	Universal Deep	E	2
S63H1316UL	13/16"	Universal Deep	E	2

Part Number	Output Size	Description	English, Metric, Accessory / Both	Quantity
S63M8UL	8 mm	Universal Deep	M	2
S63M9UL	9 mm	Universal Deep	M	2
S63M10UL	10 mm	Universal Deep	M	2
S63M11UL	11 mm	Universal Deep	M	2
S63M12UL	12 mm	Universal Deep	M	2
S63M13UL	13 mm	Universal Deep	M	2
S63M14UL	14 mm	Universal Deep	M	2
S63M15UL	15 mm	Universal Deep	M	2
S63M16UL	16 mm	Universal Deep	M	2
S63M17UL	17 mm	Universal Deep	M	2
S63M18UL	18 mm	Universal Deep	M	2
S63M19UL	19 mm	Universal Deep	M	2
S63M20UL	20 mm	Universal Deep	M	2
S63M21UL	21 mm	Universal Deep	M	2
S63M22UL	22 mm	Universal Deep	M	2
E33H	3/8"	3" Extension	A	2
E36H	3/8"	6" Extension	A	2
E312H	3/8"	12" Extension	A	2

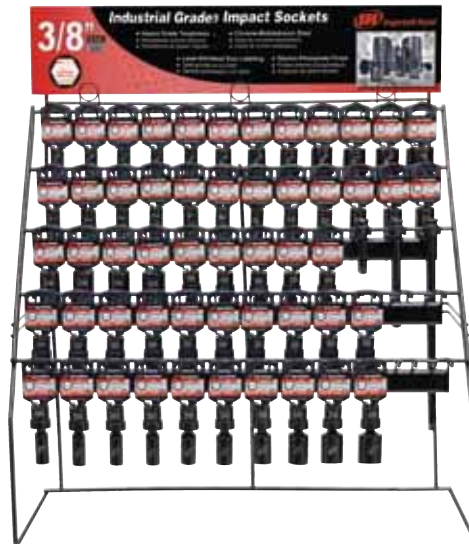

SR1 Socket Rack Only
SHD-38 Header Sign Only
Dimensions
 22" High x 24" Wide x 16" Deep

Industrial Grade Impact Socket Displays

SD-38C (Includes Socket Rack & Header Sign)

3/8" Drive Combo Length Impact

Part Number	Output Size	Description	English, Metric, Accessory / Both	Quantity
S63H516L	5/16"	Deep	E	2
S63H38L	3/8"	Deep	E	2
S63H716L	7/16"	Deep	E	2
S63H12L	1/2"	Deep	E	2
S63H916L	9/16"	Deep	E	2
S63H58L	5/8"	Deep	E	2
S63H1116L	11/16"	Deep	E	2
S63H34L	3/4"	Deep	E	2
S63H1316L	13/16"	Deep	E	2
S63H78L	7/8"	Deep	E	2
S63H1516L	15/16"	Deep	E	2
S63H1L	1"	Deep	E	2
S63M7L	7 mm	Deep	M	2
S63M8L	8 mm	Deep	M	2
S63M9L	9 mm	Deep	M	2
S63M10L	10 mm	Deep	M	2
S63M11L	11 mm	Deep	M	2
S63M12L	12 mm	Deep	M	2
S63M13L	13 mm	Deep	M	2
S63M14L	14 mm	Deep	M	2
S63M15L	15 mm	Deep	M	2
S63M16L	16 mm	Deep	M	2
S63M17L	17 mm	Deep	M	2
S63M18L	18 mm	Deep	M	2
S63M19L	19 mm	Deep	M	2
S63M20L	20 mm	Deep	M	2
S63M21L	21 mm	Deep	M	2
S63M22L	22 mm	Deep	M	2
S63H516	5/16"	Standard	E	2
S63H38	3/8"	Standard	E	2
S63H716	7/16"	Standard	E	2
S63H12	1/2"	Standard	E	2
S63H916	9/16"	Standard	E	2
S63H58	5/8"	Standard	E	2
S63H1116	11/16"	Standard	E	2
S63H34	3/4"	Standard	E	2
S63H1316	13/16"	Standard	E	2
S63H78	7/8"	Standard	E	2
S63H1516	15/16"	Standard	E	2
S63H1	1"	Standard	E	2

Part Number	Output Size	Description	English, Metric, Accessory / Both	Quantity
S63M7	7 mm	Standard	M	2
S63M8	8 mm	Standard	M	2
S63M9	9 mm	Standard	M	2
S63M10	10 mm	Standard	M	2
S63M11	11 mm	Standard	M	2
S63M12	12 mm	Standard	M	2
S63M13	13 mm	Standard	M	2
S63M14	14 mm	Standard	M	2
S63M15	15 mm	Standard	M	2
S63M16	16 mm	Standard	M	2
S63M17	17 mm	Standard	M	2
S63M18	18 mm	Standard	M	2
S63M19	19 mm	Standard	M	2
S63M20	20 mm	Standard	M	2
S63M21	21 mm	Standard	M	2
S63M22	22 mm	Standard	M	2
A3F2M	1/4"	3/8" F to 1/4" M	A	2
A3F4M	1/2"	3/8" F to 1/2" M	A	2
J3	3/8"	Universal Joint	A	2
E33H	3/8"	3" Extension	A	2
E36H	3/8"	6" Extension	A	2
E312H	3/8"	12" Extension	A	2

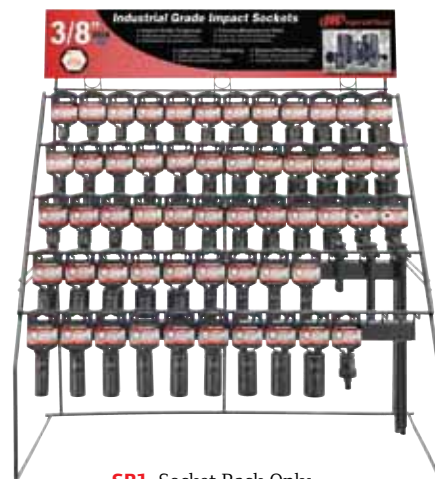

SRI Socket Rack Only
SHD-38 Header Sign Only
Dimensions
 22" High x 24" Wide x 16" Deep

Industrial Grade Impact Socket Displays

SD-12S (Includes Socket Rack & Header Sign)

1/2" Drive Standard Length Impact

Part Number	Output Size	Description	English, Metric, Accessory / Both	Quantity
S64H38	3/8"	Standard	E	2
S64H716	7/16"	Standard	E	2
S64H12	1/2"	Standard	E	2
S64H916	9/16"	Standard	E	2
S64H58	5/8"	Standard	E	2
S64H1116	11/16"	Standard	E	2
S64H34	3/4"	Standard	E	2
S64H1316	13/16"	Standard	E	2
S64H78	7/8"	Standard	E	2
S64H1516	15/16"	Standard	E	2
S64H1	1"	Standard	E	2
S64H1-116	1-1/16"	Standard	E	2
S64H1-18	1-1/8"	Standard	E	2
S64H1-316	1-3/16"	Standard	E	2
S64H1-14	1-1/4"	Standard	E	2
S64M10	10 mm	Standard	M	2
S64M11	11 mm	Standard	M	2
S64M12	12 mm	Standard	M	2
S64M13	13 mm	Standard	M	2
S64M14	14 mm	Standard	M	2
S64M15	15 mm	Standard	M	2
S64M16	16 mm	Standard	M	2
S64M17	17 mm	Standard	M	2
S64M18	18 mm	Standard	M	2
S64M19	19 mm	Standard	M	2
S64M20	20 mm	Standard	M	2
S64M21	21 mm	Standard	M	2
S64M22	22 mm	Standard	M	2
S64M23	23 mm	Standard	M	2
S64M24	24 mm	Standard	M	2
S64M26	26 mm	Standard	M	2
S64M27	27 mm	Standard	M	2
S64H716U	7/16"	Universal	E	2
S64H12U	1/2"	Universal	E	2
S64H916U	9/16"	Universal	E	2
S64H58U	5/8"	Universal	E	2
S64H1116U	11/16"	Universal	E	2
S64H34U	3/4"	Universal	E	2
S64H1316U	13/16"	Universal	E	2

Part Number	Output Size	Description	English, Metric, Accessory / Both	Quantity
S64H78U	7/8"	Universal	E	2
S64H1516U	15/16"	Universal	E	2
S64M11U	11 mm	Universal	M	2
S64M12U	12 mm	Universal	M	2
S64M13U	13 mm	Universal	M	2
S64M14U	14 mm	Universal	M	2
S64M15U	15 mm	Universal	M	2
S64M17U	17 mm	Universal	M	2
S64M18U	18 mm	Universal	M	2
S64M19U	19 mm	Universal	M	2
S64M21U	21 mm	Universal	M	2
A4F3M	3/8"	1/2" F to 3/8" M	A	2
A4F6M	3/4"	1/2" F to 3/4" M	A	2
J4	1/2"	Universal Joint	A	2

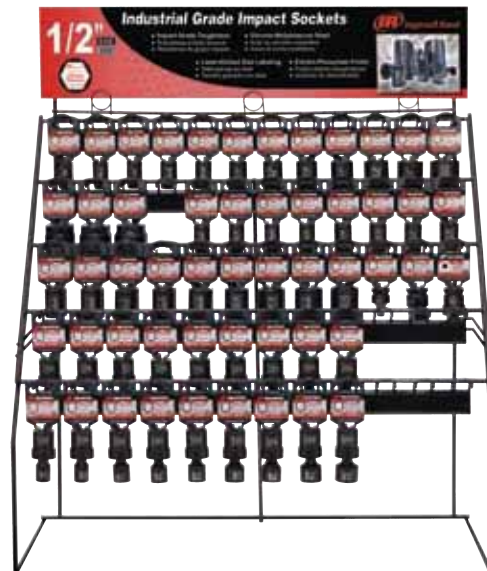

SRI Socket Rack Only

SHD-12 Header Sign Only

Dimensions

22" High x 24" Wide x 16" Deep

Industrial Grade Impact Socket Displays

SD-12D (Includes Socket Rack & Header Sign)

1/2" Drive Deep Length Impact

Part Number	Output Size	Description	English, Metric, Accessory / Both	Quantity
S64H38L	3/8"	Deep	E	2
S64H716L	7/16"	Deep	E	2
S64H12L	1/2"	Deep	E	2
S64H916L	9/16"	Deep	E	2
S64H58L	5/8"	Deep	E	2
S64H1116L	11/16"	Deep	E	2
S64H34L	3/4"	Deep	E	2
S64H1316L	13/16"	Deep	E	2
S64H78L	7/8"	Deep	E	2
S64H1516L	15/16"	Deep	E	2
S64H1L	1"	Deep	E	2
S64H1-116L	1-1/16"	Deep	E	2
S64H1-18L	1-1/8"	Deep	E	2
S64H1-316L	1-3/16"	Deep	E	2
S64H1-14L	1-1/4"	Deep	E	2
S64M10L	10 mm	Deep	M	2
S64M11L	11 mm	Deep	M	2
S64M12L	12 mm	Deep	M	2
S64M13L	13 mm	Deep	M	2
S64M14L	14 mm	Deep	M	2
S64M15L	15 mm	Deep	M	2
S64M16L	16 mm	Deep	M	2
S64M17L	17 mm	Deep	M	2
S64M18L	18 mm	Deep	M	2
S64M19L	19 mm	Deep	M	2
S64M20L	20 mm	Deep	M	2
S64M21L	21 mm	Deep	M	2
S64M22L	22 mm	Deep	M	2
S64M23L	23 mm	Deep	M	2
S64M24L	24 mm	Deep	M	2
S64M26L	26 mm	Deep	M	2
S64M27L	27 mm	Deep	M	2
S64H716UL	7/16"	Universal Deep	E	2
S64H12UL	1/2"	Universal Deep	E	2
S64H916UL	9/16"	Universal Deep	E	2
S64H58UL	5/8"	Universal Deep	E	2
S64H1116UL	11/16"	Universal Deep	E	2
S64H34UL	3/4"	Universal Deep	E	2
S64H1316UL	13/16"	Universal Deep	E	2

Part Number	Output Size	Description	English, Metric, Accessory / Both	Quantity
S64H78UL	7/8"	Universal Deep	E	2
S64H1516UL	15/16"	Universal Deep	E	2
S64M11UL	11 mm	Universal Deep	M	2
S64M12UL	12 mm	Universal Deep	M	2
S64M13UL	13 mm	Universal Deep	M	2
S64M14UL	14 mm	Universal Deep	M	2
S64M15UL	15 mm	Universal Deep	M	2
S64M17UL	17 mm	Universal Deep	M	2
S64M18UL	18 mm	Universal Deep	M	2
S64M19UL	19 mm	Universal Deep	M	2
S64M21UL	21 mm	Universal Deep	M	2
E43H	1/2"	3" (E475MM 75 MM)	A	2
E45H	1/2"	5" (E4125MM 125 MM)	A	2
E410H	1/2"	10" (E4250MM 250 MM)	A	2

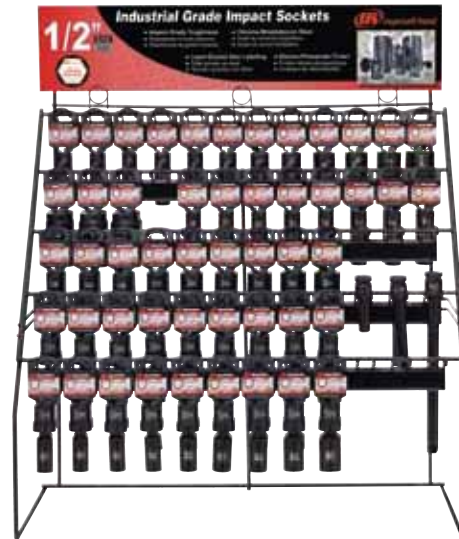

SR1 Socket Rack Only
SHD-12 Header Sign Only
Dimensions
 22" High x 24" Wide x 16" Deep

Industrial Grade Impact Socket Displays

SD-12C (Includes Socket Rack & Header Sign)

1/2" Drive Combo Length Impact

Part Number	Output Size	Description	English, Metric, Accessory / Both	Quantity
S64H38	3/8"	Standard	E	2
S64H716	7/16"	Standard	E	2
S64H12	1/2"	Standard	E	2
S64H916	9/16"	Standard	E	2
S64H58	5/8"	Standard	E	2
S64H1116	11/16"	Standard	E	2
S64H34	3/4"	Standard	E	2
S64H1316	13/16"	Standard	E	2
S64H78	7/8"	Standard	E	2
S64H1516	15/16"	Standard	E	2
S64H1	1"	Standard	E	2
S64H1-116	1-1/16"	Standard	E	2
S64H1-18	1-1/8"	Standard	E	2
S64H1-316	1-3/16"	Standard	E	2
S64H1-14	1-1/4"	Standard	E	2
S64M10	10 mm	Standard	M	2
S64M11	11 mm	Standard	M	2
S64M12	12 mm	Standard	M	2
S64M13	13 mm	Standard	M	2
S64M14	14 mm	Standard	M	2
S64M15	15 mm	Standard	M	2
S64M16	16 mm	Standard	M	2
S64M17	17 mm	Standard	M	2
S64M18	18 mm	Standard	M	2
S64M19	19 mm	Standard	M	2
S64M20	20 mm	Standard	M	2
S64M21	21 mm	Standard	M	2
S64M22	22 mm	Standard	M	2
S64M23	23 mm	Standard	M	2
S64M24	24 mm	Standard	M	2
S64M26	26 mm	Standard	M	2
S64M27	27 mm	Standard	M	2
S64H38L	3/8"	Deep	E	2
S64H716L	7/16"	Deep	E	2
S64H12L	1/2"	Deep	E	2
S64H916L	9/16"	Deep	E	2
S64H58L	5/8"	Deep	E	2
S64H1116L	11/16"	Deep	E	2
S64H34L	3/4"	Deep	E	2
S64H1316L	13/16"	Deep	E	2
S64H78L	7/8"	Deep	E	2
S64H1516L	15/16"	Deep	E	2
S64H1L	1"	Deep	E	2
S64H1-116L	1-1/16"	Deep	E	2
S64H1-18L	1-1/8"	Deep	E	2
S64H1-316L	1-3/16"	Deep	E	2
S64H1-14L	1-1/4"	Deep	E	2

Part Number	Output Size	Description	English, Metric, Accessory / Both	Quantity
S64M10L	10 mm	Deep	M	2
S64M11L	11 mm	Deep	M	2
S64M12L	12 mm	Deep	M	2
S64M13L	13 mm	Deep	M	2
S64M14L	14 mm	Deep	M	2
S64M15L	15 mm	Deep	M	2
S64M16L	16 mm	Deep	M	2
S64M17L	17 mm	Deep	M	2
S64M18L	18 mm	Deep	M	2
S64M19L	19 mm	Deep	M	2
S64M20L	20 mm	Deep	M	2
S64M21L	21 mm	Deep	M	2
S64M22L	22 mm	Deep	M	2
S64M23L	23 mm	Deep	M	2
S64M24L	24 mm	Deep	M	2
S64M26L	26 mm	Deep	M	2
S64M27L	27 mm	Deep	M	2
A4F3M	3/8"	1/2" F to 3/8" M	A	2
A4F6M	3/4"	1/2" F to 3/4" M	A	2
J4	1/2"	Universal Joint	A	2
E43H	1/2"	3" (E475MM 75 MM)	A	2
E45H	1/2"	5" (E4125MM 125 MM)	A	2
E410H	1/2"	10" (E4250MM 250 MM)	A	2

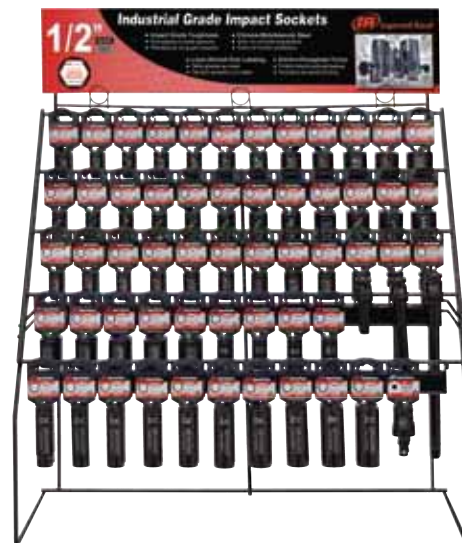

SR1 Socket Rack Only
SHD-12 Header Sign Only
Dimensions
 22" High x 24" Wide x 16" Deep

Industrial Grade Impact Socket Displays

SD-34 (Includes Header Sign & Socket Rack)

3/4" Drive Standard and Deep Length Impacts

Part Number	Output Size	Description	English, Metric, Accessory / Both	Quantity
S66H12	1/2"	Standard	E	1
S66H916	9/16"	Standard	E	1
S66H58	5/8"	Standard	E	1
S66H1116	11/16"	Standard	E	1
S66H34	3/4"	Standard	E	1
S66H1316	13/16"	Standard	E	1
S66H78	7/8"	Standard	E	1
S66H1516	15/16"	Standard	E	1
S66H1	1"	Standard	E	1
S66H1-116	1-1/16"	Standard	E	1
S66H1-18	1-1/8"	Standard	E	1
S66H1-316	1-3/16"	Standard	E	1
S66H1-14	1-1/4"	Standard	E	1
S66H1-516	1-5/16"	Standard	E	1
S66H1-38	1-3/8"	Standard	E	1
S66H1-716	1-7/16"	Standard	E	1
S66H1-12	1-1/2"	Standard	E	1
S66H1-916	1-9/16"	Standard	E	1
S66H1-58	1-5/8"	Standard	E	1
S66H1-1116	1-11/16"	Standard	E	1
S66H1-34	1-3/4"	Standard	E	1
S66H1-1316	1-13/16"	Standard	E	1
S66H1-78	1-7/8"	Standard	E	1
S66H1-1516	1-15/16"	Standard	E	1
S66H2	2"	Standard	E	1
S66H12L	1/2"	Deep	E	1
S66H916L	9/16"	Deep	E	1
S66H58L	5/8"	Deep	E	1
S66H1116L	11/16"	Deep	E	1
S66H34L	3/4"	Deep	E	1
S66H1316L	13/16"	Deep	E	1
S66H78L	7/8"	Deep	E	1
S66H1516L	15/16"	Deep	E	1
S66H1L	1"	Deep	E	1
S66H1-116L	1-1/16"	Deep	E	1
S66H1-18L	1-1/8"	Deep	E	1
S66H1-316L	1-3/16"	Deep	E	1
S66H1-14L	1-1/4"	Deep	E	1
S66H1-516L	1-5/16"	Deep	E	1

Part Number	Output Size	Description	English, Metric, Accessory / Both	Quantity
S66H1-38L	1-3/8"	Deep	E	1
S66H1-716L	1-7/16"	Deep	E	1
S66H1-12L	1-1/2"	Deep	E	1
S66H1-916L	1-9/16"	Deep	E	1
S66H1-58L	1-5/8"	Deep	E	1
S66H1-1116L	1-11/16"	Deep	E	1
S66H1-34L	1-3/4"	Deep	E	1
S66H1-1316L	1-13/16"	Deep	E	1
S66H1-78L	1-7/8"	Deep	E	1
S66H1-1516L	1-15/16"	Deep	E	1
S66H2L	2"	Deep	E	1
A6F4M	1/2"	3/4" F to 1/2" M	A	1
A6F8M	1"	3/4" F to 1" M	A	1
J6	3/4"	Universal Joint	A	1
E67H	3/4"	7" (E6175MM 175 MM)	A	1



SR2 Socket Rack Only

SHD-34 Header Sign Only

Dimensions

27-1/4" High x 24-1/2" Wide x 2" Deep

Industrial Grade Impact Socket Displays

S-1 (Includes Header Sign & Socket Rack)

1" Drive Standard and Deep Length Impacts

Part Number	Output Size	Description	English, Metric, Accessory / Both	Quantity
S68H34	3/4"	Standard	E	1
S68H1316	13/16"	Standard	E	1
S68H78	7/8"	Standard	E	1
S68H1516	15/16"	Standard	E	1
S68H1	1"	Standard	E	1
S68H1-116	1-1/16"	Standard	E	1
S68H1-14	1-1/4"	Standard	E	1
S68H1-1316	1-13/16"	Standard	E	1
S68H1-14	1-1/4"	Standard	E	1
S68H1-516	1-5/16"	Standard	E	1
S68H1-38	1-3/8"	Standard	E	1
S68H1-716	1-7/16"	Standard	E	1
S68H1-12	1-1/2"	Standard	E	1
S68H1-916	1-9/16"	Standard	E	1
S68H1-58	1-5/8"	Standard	E	1
S68H1-1116	1-11/16"	Standard	E	1
S68H1-34	1-3/4"	Standard	E	1
S68H1-1316	1-13/16"	Standard	E	1
S68H1-78	1-7/8"	Standard	E	1
S68H1-1516	1-15/16"	Standard	E	1
S68H2	2"	Standard	E	1
S68H34L	3/4"	Deep	E	1
S68H1316L	13/16"	Deep	E	1
S68H78L	7/8"	Deep	E	1
S68H1516L	15/16"	Deep	E	1
S68H1L	1"	Deep	E	1
S68H1-116L	1-1/16"	Deep	E	1
S68H1-18L	1-1/8"	Deep	E	1
S68H1-316L	1-3/16"	Deep	E	1
S68H1-14L	1-1/4"	Deep	E	1
S68H1-516L	1-5/16"	Deep	E	1
S68H1-38L	1-3/8"	Deep	E	1
S68H1-716L	1-7/16"	Deep	E	1
S68H1-12L	1-1/2"	Deep	E	1
S68H1-916L	1-9/16"	Deep	E	1
S68H1-58L	1-5/8"	Deep	E	1
S68H1-1116L	1-11/16"	Deep	E	1

Part Number	Output Size	Description	English, Metric, Accessory / Both	Quantity
S68H1-34L	1-3/4"	Deep	E	1
S68H1-1316L	1-13/16"	Deep	E	1
S68H1-78L	1-7/8"	Deep	E	1
S68H1-1516L	1-15/16"	Deep	E	1
S68H2L	2"	Deep	E	1
A8F6M	3/4"	1" F to 3/4" M	A	1
E87H	1"	7" (E8175MM 175 MM)	A	1



SR2 Socket Rack Only

SHD-1 Header Sign Only

Dimensions

27-1/4" High x 23-1/2" Wide x 2" Deep

Air Ratchets

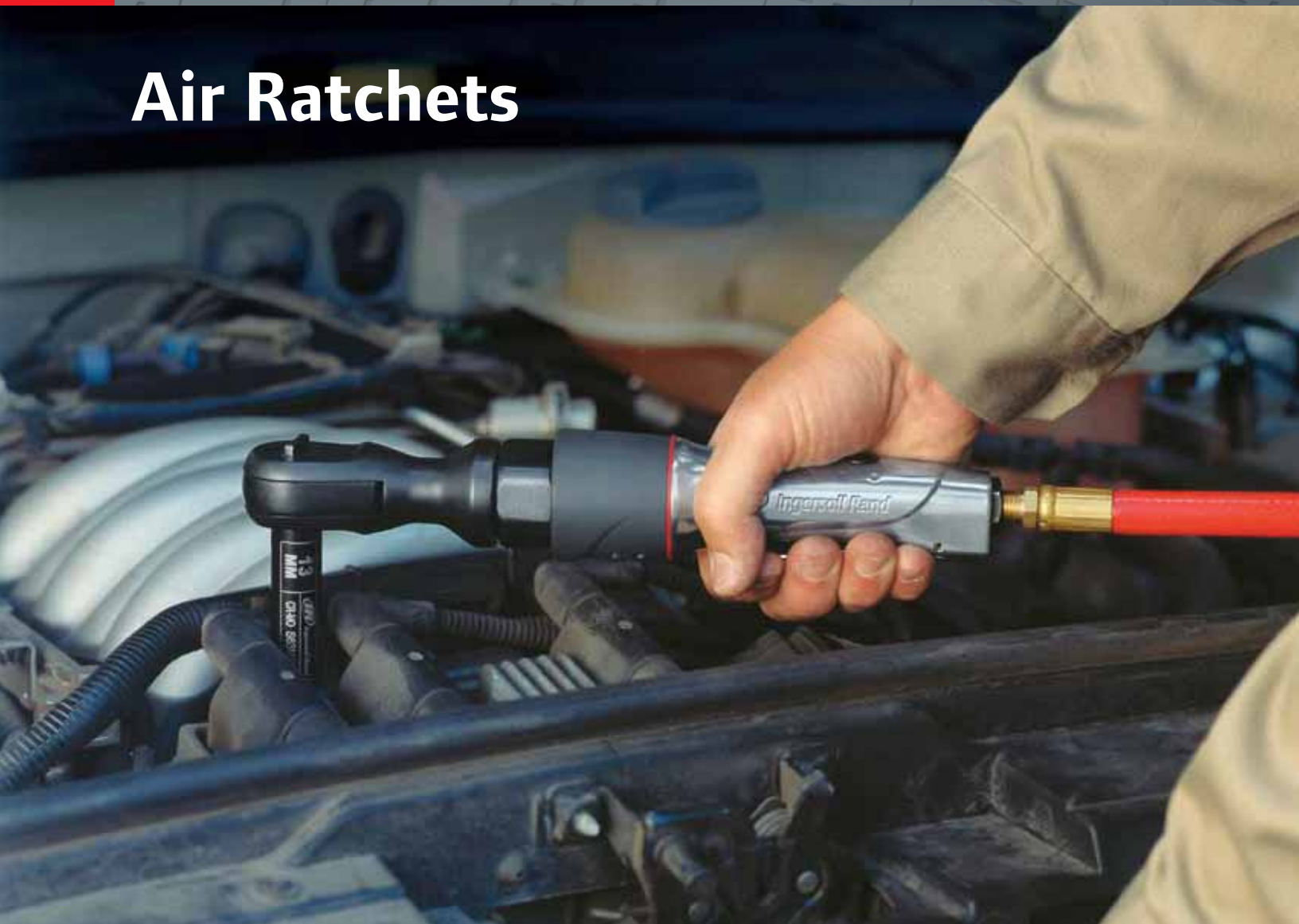

For more than 100 years, Ingersoll Rand has been designing world-class tools of the highest quality, durability, and reliability. This legacy of excellence and performance is evident in our line of pneumatic ratchets. Smaller in size and more powerful than competitive models, our ratchets are specifically engineered to make your job easier and you more productive. Our ratchets are also very convenient to use, thanks to enhanced ergonomics.



Air Ratchets

Model	Square Drive	Max Torque ft-lb (Nm)	Free Speed rpm	Weight lb (kg)	Length in (mm)	Average Air Consumption cfm (L/min)	Average Air Consumption @ Load cfm (L/min)	Sound Pressure / Power dBA	Air Inlet NPTF in	Min Hose Size in (mm)
1/4" SQUARE DRIVE										
103A	1/4"	20 (27)	200	1.1 (0.5)	6.5" (165)	2.5 (71)	15 (425)	88 / 99	1/4"	3/8" (10)
104B	1/4"	20 (27)	200	1.1 (0.5)	7.8" (198)	2.2 (61)	13 (368)	88 / 97	1/4"	3/8" (10)
1103	1/4"	25 (34)	270	1.3 (0.6)	7.5" (190)	3.5 (99)	21 (595)	86.6 / 97.6	1/4"	3/8" (10)
1215Ti	1/4"	25 (34)	225	1.5 (0.7)	8" (203)	3.5 (99)	21 (595)	90 / 101	1/4"	3/8" (10)
3/8" SQUARE DRIVE										
1033A*	3/8"	20 (27)	200	1.1 (0.5)	6.5" (165)	2.5 (71)	15 (425)	88 / 99	1/4"	3/8" (10)
1133*	3/8"	25 (34)	270	1.3 (0.6)	7.5" (190)	3.5 (99)	21 (595)	86.6 / 97.6	1/4"	3/8" (10)
1225Ti*	3/8"	25 (34)	270	1.5 (0.7)	8" (203)	4 (113)	21 (595)	90 / 101	1/4"	3/8" (10)

*Not pictured.

103A

Air Ratchet Wrench

This air wrench lets you squeeze into very snug spaces without feeling squeezed while you run small fasteners. Excellent for body shop repair jobs and light-duty work under the dashboard.

- Our smallest air ratchet, only 6.5" long
- Lightweight, only 1.1 lb
- 20 ft-lb maximum torque



104B

Air Ratchet Wrench

Made to fit in the palm of your hand, this compact ratchet is great for small engine repair, headlight service work, and bench work. So easy to maintain — just dip the head in oil.

- Extra-compact
- Easy to maintain
- 20 ft-lb maximum torque



1103

Air Ratchet Wrench

The 1103 puts the power and speed of a larger tool neatly in the palm of your hand. It's perfect for access under the hood, under the dash, and for collision repair.

- Exclusive TwinPawl Plus™ head design for durability and long life
- 2-speed power grip ring; ergonomic textured grip
- 25 ft-lb maximum torque; 270 rpm



1215Ti

Air Ratchet Wrench

The enhanced design of the 1215Ti gives you easy access to those knuckle-scraping repairs. You can count on it to deliver the power you need and the reliability and durability you expect.

- Best-in-class torque
- Easy one-handed operation
- Captured head design reduces weight and eliminates "head-spreading"



Air Ratchet Repair Kits



Keep your Ingersoll Rand air ratchet running strong with our genuine repair kits and parts — found on page 45.

Air Ratchets

Model	Square Drive	Max Torque ft-lb (Nm)	Free Speed rpm	Weight lb (kg)	Length in (mm)	Average Air Consumption cfm (L/min)	Average Air Consumption @ Free Speed cfm (L/min)	Sound Pressure / Power dBA	AirInlet NPTF in	Min Hose Size in (mm)
3/8" SQUARE DRIVE										
111*	3/8"	50 (68)		2.7 (1.2)	10.5" (267)	4 (113)	12 (340)	86.6 / 97.6	1/4"	3/8" (10)
107XPA	3/8"	54 (73)	160	2.75 (1.25)	11" (279)	4 (85)	19 (510)	94.4 / 100.4	1/4"	3/8" (10)
1200	3/8"	60 (81)	275	2.7 (1.2)	10.7" (272)	5 (142)	30 (850)	94.7 / 105.7	1/4"	3/8" (10)
109XPA	3/8"	76 (95)	220	3.3 (1.4)	12" (302)	4 (113)	24 (680)	92.4 / 103.4	1/4"	3/8" (10)
1/2" SQUARE DRIVE										
1111	1/2"	50 (68)		2.7 (1.2)	10.5" (267)	4 (113)	12 (340)	86.6 / 97.6	1/4"	3/8" (10)
1077XPA*	1/2"	54 (73)	160	2.75 (1.25)	11" (279)	4 (85)	19 (510)	94.4 / 105.4	1/4"	3/8" (10)
1210*	1/2"	60 (81)	275	2.7 (1.2)	10.7" (272)	5 (142)	30 (850)	94.7 / 105.7	1/4"	3/8" (10)
1099XPA*	1/2"	76 (95)	220	3.3 (1.4)	12" (302)	4 (113)	24 (680)	92.4 / 103.4	1/4"	3/8" (10)

*Not pictured.

107XPA

Air Ratchet Wrench

Based on the industry's most popular ratchet, the 107XPA delivers an extra measure of durability with an advanced head design, plus a host of other features.

- 54 ft-lb maximum torque
- 360° adjustable exhaust directs air away from the operator and the work
- Variable speed lever-style throttle



1200

Air Ratchet Wrench

Superior comfort and control meet durability and productivity in this tough, high-speed ratchet.

- Lightweight composite handle for superior comfort and grip
- Head design features exclusive slip-resistant friction disc for longer life and added durability



109XPA

Air Ratchet Wrench

Optimized gear ratio and airflow for extra performance, coupled with exceptional durability.

- 76 ft-lb maximum torque at 220 rpm free speed
- 360° adjustable exhaust directs air away from the operator and the work
- Variable speed button trigger



1111

Knuckle Saver™

This revolutionary Reactionless Ratchet™ has a unique reactionless mechanism. It makes gearing unnecessary and absorbs kickback when the nut runs tight.

- Up to 50 ft-lb torque
- Fastest air ratchet you can buy
- Rear exhaust directs air away from work



Reactionless Ratchet

Air Ratchet Boots



Even the industry's hardest-working air ratchets could use added protection from the rigors of the jobsite. Our air ratchet boots and accessories can be found on page 45.

Air Ratchet Accessories

Extend the life of your tools with genuine Ingersoll Rand repair kits and replacement parts. Every Ingersoll Rand part is specifically designed to enhance durability and improve the productivity of your tool.

Air Ratchet Repair Kits

Part Number	For Use With
107XPA-SK	107XPA, 1077XPA
109XPA-SK	109XPA, 1099XPA
1103-SK	1103, 1133
1200-SK	1200, 1210
1215-SK	1215Ti, 1225Ti



1077XPA-SK

Air Ratchet Tune-up Kits

Part Number	For Use With
107XPA-TK1	107XPA, 1077XPA
109XPA-TK1	109XPA, 1099XPA
110-TK1	111, 1111
1200-TK1	1200, 1210



1200-TK1

Boots

Part Number	Description	For Use With
103-BOOT	Ratchet head boot with Ingersoll Rand logo printed on red boot	104B, 103A, 1033A, R140
107-BOOT	Ratchet head boot with Ingersoll Rand logo printed on red boot	107XP, 107XPA, 1077XP, 1077XPA, R380
109-BOOT	Ratchet head boot with Ingersoll Rand logo printed on red boot	109XP, 109XPA, 1099XP, 1099XPA
1103-BOOT	Ratchet head boot with Ingersoll Rand logo printed on red boot	1103, 1133
1215-BOOT	Ratchet head boot with Ingersoll Rand logo printed on red boot	1215Ti



107-BOOT



1215-BOOT

Air Ratchet Head Repair Kits

Part Number	For Use With
103A-TRK-1	103A, 104B
1033A-TRK1	1033A
107XPA-TRK1	107XPA
1077XPA-TRK1	1077XPA
109XPA-TRK1	109XPA
1099XPA-TRK1	1099XPA
1103-TRK1	1103
111-TRK1	111
1111-TRK1	1111
1133-TRK1	1133
1200-TRK1	1200
1210-TRK1	1210
1215-TRK1	1215Ti
1225-TRK1	1225Ti



1107-TRK1

Comfort Grips

Part Number	Description	For Use With
CG-6X8	6" x 8" sheet of comfort grip material	All tools

- Cut to size to fit your tool

Air Cutting Tools and Grinders

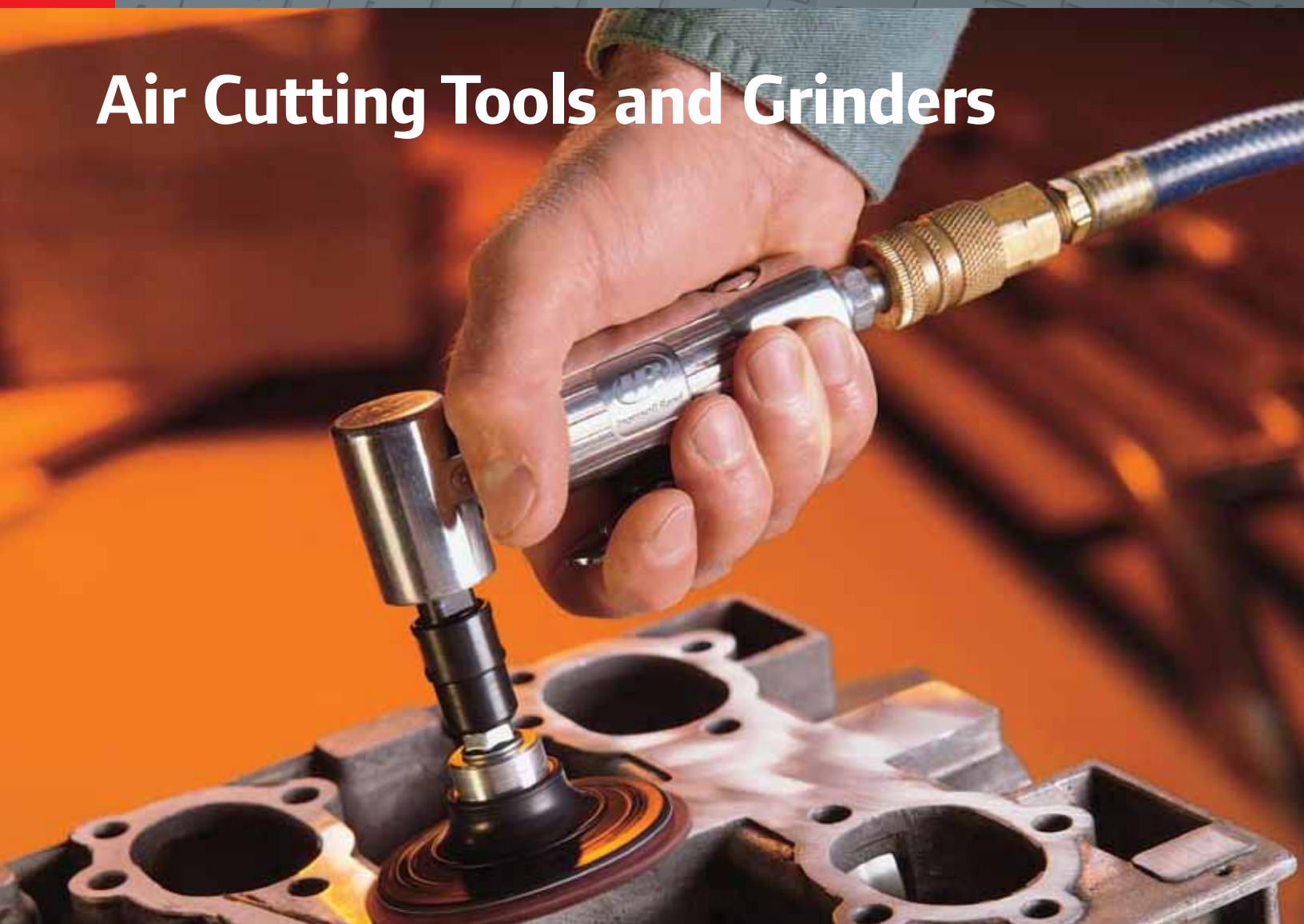

With high-strength steels, advanced plastics, and new composite materials in today's cars and trucks, you need versatile tools for precise, controlled cutting. Ingersoll Rand cutting tools are the reliable choice of auto body and repair shops, used for everything from muffler and exhaust work to sunroof installations and body repairs.

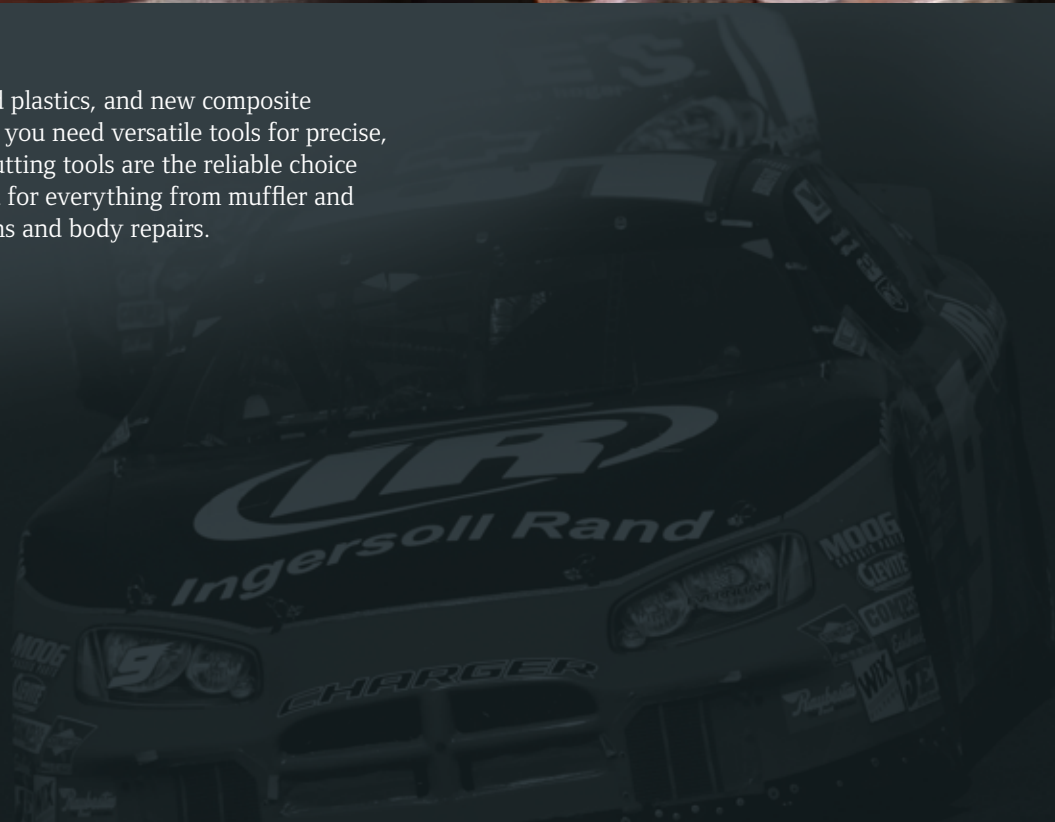

Air Grinders

Model	Rated Power hp (kW)	Free Speed rpm	Collet Size in	Weight lb (kg)	Length in (mm)	Average Air Consumption cfm (L/min)	Average Air Consumption @ Load cfm (L/min)	Sound Pressure / Power dBA	Air Inlet NPTF in	Min Hose Size in (mm)
301	0.25 (0.19)	20,000	1/4"	0.99 (0.45)	5" (127)	3 (85)	14 (396)	91.8 / 104.8	1/4"	3/8" (10)
302A	0.25 (0.19)	18,000	1/4"	0.97 (0.44)	5" (127)	3 (85)	12 (340)	94 / 105	1/4"	3/8" (10)
307A	0.25 (0.19)	27,000	1/4"	0.69 (0.31)	4.75" (121)	3 (85)	14 (396)	83 / 94	1/4"	3/8" (10)
308A	0.5 (0.37)	25,000	1/4"	1.16 (0.53)	5.63" (143)	3 (85)	20 (566)	91 / 120	1/4"	3/8" (10)

301

Multi-purpose Air Angle Die Grinder

Part of an expanded line of economical, heavy-duty grinders, the 301 packs valuable features into a compact package. Use it for grinding, edge-breaking, deburring, porting, and polishing. Wherever space is tight, its right-angle configuration provides easy access.

- Compact, lightweight, and easy to handle
- Self-locking throttle
- Precision-machined gearing delivers maximum power transfer



302A

Air Angle Die Grinder

When a straight tool isn't practical for working in confined areas, this economical die grinder with a right-angle head is the one to use. It's compact and well-designed for grinding, porting, polishing, deburring, and breaking sharp edges.

- Precision-machined steel gears
- Positive grip 1/4"-capacity collet chuck
- Self-locking throttle lever



307A

Mini Air Die Grinder

The 307A combines performance and versatility in a lightweight, compact package. It can be used with all types of accessories for porting, weld breaking, and smoothing sharp edges, as well as deburring, polishing, and grinding.

- Standard 1/4" collet for all types of accessories
- Safety lever prevents accidental starts
- Front exhaust helps keep work surface clean



308A

Air Die Grinder

A durable yet economical choice offering longer life and higher free speed at 25,000 rpm, this general-purpose tool is designed for porting, light weld grinding, and breaking sharp edges.

- Comes with two collet wrenches
- Self-locking throttle lever
- Positive grip 1/4"-capacity collet chuck



Carbide Grinding Burr Kits



Our carbide burs set the industry standard for quality, and come in a variety of types, styles, and sizes. See pages 51 and 52 for our complete line of Ingersoll Rand air cutting tools and grinder accessories.

Surface Conditioning Kits

Model	Rated Power hp (kW)	Speed rpm	Output	Free Weight lb (kg)	Length in (mm)	Average Air Consumption cfm (L/min)	Average Air Consumption @ Load cfm (L/min)	Sound Pressure / Power dBA	Air Inlet NPTF in	Min Hose Size in (mm)
301	0.25 (0.19)	20,000	1/4" Collet	0.99 (0.45)	5" (127)	3 (85)	14 (396)	90 / 103	1/4"	3/8" (10)
307-K	0.25 (0.19)	27,000	1/4" Collet	0.69 (0.31)	4.75" (121)	3 (85)	14 (396)	84.7 / 97.7	1/4"	3/8" (10)

Tool info for all 301 Series kits.

301-2MK

Surface Conditioning Kit

Ingersoll Rand has packed the 301 in a strong, blow-molded plastic case along with four coarse and four medium grit 2" Roloc™ surface conditioning pads and a disc holder.



301-32MK

Surface Conditioning Kit

This kit contains the 301 in a strong, blow-molded plastic case along with two coarse and two medium grit 3" Roloc surface conditioning pads, two coarse, two medium grit 2" Roloc surface conditioning pads, and two disc holders.



301-3MK

Surface Conditioning Kit

Four coarse and four medium grit 3" Roloc surface conditioning pads are packed in a strong blow-molded case with our popular 301 grinder.



301-K

Die Grinder Kit

Ingersoll Rand has packed the 301 in a strong, blow-molded plastic case complete with 10 mounted grinding tips.



3102K

Die Grinder Kit

For the ultimate performance and versatility in a lightweight package with superior maneuverability in an angle grinder, the 3102 is the perfect choice. The 3102 features a composite grip for superior ergonomics and comfort. This powerful grinder can be used in a variety of applications, including porting, weld braking, deburring, grinding, polishing, etc. The kit includes the 3102 Grinder, 2" and 3" Quick Change Backing Pads, along with a variety of 2" and 3" Quick Change Sanding Disks, 2" and 3" Quick Change Coarse and Medium Polishing Disks, all packaged in a strong, blow-molded plastic case.



307-K

Die Grinder Kit

The 307-K comes with 10 mounted grinding tips in a strong, blow-molded case.



4102K

Surface Preparation Kit

Along with the versatile, lightweight, and powerful 3102 Angle Grinder, this Kit comes along with the ultimate in Random Orbital Sanders, the 4151-HL. The 4151-HL adds to the Kit the benefit of a lightweight, 6" pad, 12,000 RPM, vacuum-ready, random orbital sander for all of the fine-finish requirements for the job at hand. Along with the Angle Grinder and the Random Orbital Sander, the kit includes a 3" Quick Change Backing Pad, 3" Quick Change Sanding Disks, 3" Quick Change Coarse and Medium Polishing Disks, a 6" Hook and Loop Backing Pad, and 6" Sanding Disks, all packaged in a strong, blow-molded plastic case.



3108K

Die Grinder Kit

The 3108 features a composite grip for superior ergonomics and comfort. These powerful die grinders can be used in various applications including porting, weld braking, deburring, polishing, grinding, and more.



Air Grinders

Model	Rated Power hp (kW)	Free Speed rpm	Output	Weight lb (kg)	Length in (mm)	Average Air Consumption cfm (L/min)	Average Air Consumption @ Load cfm (L/min)	Sound Pressure / Power dBA	Air Inlet NPTF in	Min Hose Size in (mm)
3102	0.33 (0.25)	20,000	1/4" Collet	1.27 (.58)	6.75" (171)	3 (85)	18 (510)	90 / 101	1/4"	3/8" (10)
3108	0.33 (0.25)	25,000	1/4" Collet	1.27 (.58)	6.75" (171)	3 (85)	18 (510)	92 / 103	1/4"	3/8" (10)
326	N/A	18,000	N/A	2.3 (1.04)	8.88" (226)	10 (283)	25 (708)	94.3 / 107.3	1/4"	3/8" (10)
3445	0.8 (.59)	12,000	5/8" - 11 Thread	3.7 (1.7)	9.25" (235)	9 (255)	26.5 (750)	82.7 / 95.6	1/4"	3/8" (10)
MINI TOOL SURFACE PREP GRINDER KIT										
3103K	0.2 (0.15)	15,000	1/4" - 20 Thread	0.99 (0.45)	5"	2.07	19.4	84.9 / 95.9	1/4"	3/8" (10)

3102

Composite Die Grinder

For the ultimate performance and versatility in a lightweight package with superior maneuverability, these grinders are the perfect choice. The 3102 features a composite grip for superior ergonomics and comfort. These powerful die grinders can be used in various applications including porting, weld braking, deburring, polishing, and grinding, just to name a few.

- 20,000 rpm
- Safety release throttle
- Positive grip 1/4"-capacity collet chuck



3108

Composite Die Grinder

The 3108 features a composite grip for superior ergonomics and comfort. These powerful die grinders can be used in various applications including porting, weld braking, deburring, polishing, grinding, and more.

- 25,000 rpm
- Safety release throttle
- Positive grip 1/4"-capacity collet chuck



3103K

Mini Surface Prep Grinder Kit

- Ball-bearing construction enhances durability and smooth power delivery
- Double-sided, adjustable speed settings provide variability for a broader range of applications
- Kit includes 14-piece 2" and 3" sanding discs



Remove
rough spots
quickly
and easily

326

Cut-off Tool

The heavy-duty cut-off tool is designed for durability and on-the-job performance. Ideal for cutting mufflers, tail pipes, sheet metal, nuts, and bolts.

- Provides 18,000 rpm for fast cutting
- Steel shield deflects debris away from operator
- Large hooked locking throttle lever provides user comfort and safety



3445

Air Angle Grinder

The 3445 is the perfect choice for high performance finishing. This 4-1/2" air angle grinder combines a unique motor controller that virtually eliminates overspeeding — with a powerful 0.8 hp motor to provide plenty of power for rust and material removal.

- Rear exhaust with piped-away option
- Composite grip for improved comfort
- Locking lever with tease throttle



Abrasive Convenience Packs



In addition to our abrasive convenience packs, Ingersoll Rand offers a line of 2" and 3" surface conditioning discs designed to maximize the productivity of our air grinders while ensuring the best possible finishes. See pages 51 and 52 for our full line of cutting tool and grinder accessories.

Air Cutting Tools

Model	Strokes Per Minute	Weight lb (kg)	Length in (mm)	Average Air Consumption cfm (L/min)	Average Air Consumption @ Load cfm (L/min)	Sound Pressure / Power dBA	Air Inlet NPTF in	Min Hose Size in (mm)
7802SA	4,200	2.8 (1.27)	9.4" (239)	4 (113)	21 (595)	N/A	1/4"	3/8" (10)
325	3,200	2.1 (0.95)	7.3" (185)	4 (113)	17 (481)	90.2 / 103.2	1/4"	3/8" (10)
429	10,000	1.32 (0.6)	8.25" (210)	9 (255)	7 (198)	87.3 / 100.3	1/4"	3/8" (10)
4429*	5,750	1.63 (0.74)	9.25" (235)	4 (113)	7.6 (215)	69.2 / 82.2	1/4"	3/8" (10)

*Not pictured.

7802SA

Air Shear

This versatile cutting shear that makes clean cuts in cold-rolled steel up to 20-gauge without chips is ideal for body shops, sheet metal shops, air-conditioning fabricators, plastic fabricators, heating contractors, and machine shops.

- Cuts squares, angles, and circles
- Long-life tool with heavy-duty cutting blades
- Shears most types of plastics and all types of aluminum, tin, and steel

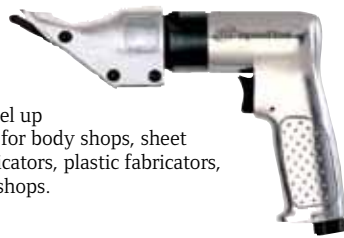

325

Air Nibbler

Get a bigger bite and better angle cuts with our Air Nibbler. Instead of shearing or sawing, the tool actually "nibbles" cold-rolled steel, plastic, tin, aluminum, and other metals, up to 18-gauge thicknesses at a rate of more than 6' per minute. It's ideal for paint and auto body shops, tinsmiths, and sheet metal shops.

- Cuts out quarter panels without distorting the edges of the material
- Starts cuts in the center of a panel
- Holds a tight 1/4" radius with great accuracy



429

Air Reciprocating Saw

The 429 is a versatile air saw for cutting intricate shapes and light radius curves in all types of plastics, fiberglass, and composite materials, as well as aluminum and sheet metal. This reduced vibration tool is excellent for body shop repair, muffler and exhaust work, and sunroof installations.

- Comes with 6 high-speed steel cutting blades and 2 hex wrenches
- Cuts flat and curved surfaces
- Durable, long-life tool



Saw Blades



Saw blades, cutting tools, and all other grinder accessories can be found on pages 51 and 52.

Comfort Grips

Part Number	Description	For Use With
SURFACE PREPARATION GRIPS		
CG-6X8	6" x 8" sheet of comfort grip material	All tools

- Cut to size to fit your tool

Carbide Grinding Burr Kits

Ingersoll Rand carbide burrs are titanium nitride (TiN) coated to provide maximum edge retention and corrosion resistance. The TiN coating can improve the average lifetime of the burr by more than three times.

Note: Burrs have a maximum operating speed of 40,000 rpm.



1814TiN



1438TiN



M30TiN

The 30 piece, carbide burr mega set covers a wide range of applications. Handy storage box keeps burrs organized and ready for use.

Part Number	Description	Description
1814TiN	6-piece carbide burr kit	TiN coated carbide burrs — 1/8" shank, 1/4" head diameter with soft-sided case
618TiN	6-piece carbide burr kit	TiN coated carbide burrs — 1/8" shank, 1/4" and 1/8" head diameters with soft-sided case
1818TiN	6-piece carbide burr kit	TiN coated carbide burrs — 1/8" shank, 1/8" head diameter with soft-sided case
1816TiN	6-piece carbide burr kit	TiN coated carbide burrs — 1/8" shank, various head diameters with soft-sided case
1438TiN	6-piece carbide burr kit	TiN coated carbide burrs — 1/4" shank, 3/8" head diameter with soft-sided case
614TiN	6-piece carbide burr kit	TiN coated carbide burrs — 1/4" shank, 1/2" and 3/8" head diameters with soft-sided case
1412TiN	6-piece carbide burr kit	TiN coated carbide burrs — 1/4" shank, 1/2" head diameter with soft-sided case
M30TiN	30-piece carbide burr mega set	TiN coated carbide burrs — 1/4" and 1/2" shank, various head diameters and shapes with hard case
814TiN	8-piece carbide burr kit	TiN coated carbide burrs — 1/4" shank, 1/2" and 3/8" head diameters with hard case

Abrasive Convenience Packs

Part Number	Description
SANDING VARIETY GRIT PACKS	
02A-VARAO-6	2" AO Series sanding discs — 2 each 36, 50, 80 grit
03A-VARAO-6	3" AO Series sanding discs — 2 each 36, 50, 80 grit
02A-VARCO-6	2" CO Series sanding discs — 2 each 36, 50, 80 grit
03A-VARCO-6	3" CO Series sanding discs — 2 each 36, 50, 80 grit
23A-VARAO-6	2" and 3" AO Series sanding discs — 1 each 36, 50, 80 grit
SURFACE CONDITIONING / VARIETY GRIT PACKS	
02A-VARBR-5	2" surface preparation discs — 2 each coarse and medium, 1 very fine
03A-VARBR-5	3" surface preparation discs — 2 each coarse and medium, 1 very fine
23A-VARBR-6	2" and 3" surface preparation discs — 1 each coarse, medium, 1 very fine
HIGH STRENGTH — BLENDING AND BUFFING DISCS	
02A-MEDHS-4	2" medium-grade, blending kit 3 discs with backing pad and post
03A-MEDHS-4	3" medium-grade, blending kit 3 discs with backing pad and post
QUICK STRIP — PAINT AND CORROSION DISCS	
02A-CRSBS-4	2" coarse quick-strip kit 3 discs with backing pad and post
03A-CRSBS-4	3" coarse quick-strip kit 3 discs with backing pad and post
COMPLETE SURFACE CONDITIONING KITS	
02A-VAR-KIT	2" complete surface preparation kit with backing pad and post
03A-VAR-KIT	3" complete surface preparation kit with backing pad and post



Cut-off Wheels

Part Number	Description
9520	3" diameter cutting discs (5 pack)
9521	3" diameter cutting discs (50 pack)



Bi-metal Reciprocating Saw Blades

These Bi-metal technology blades are created using a solid-state diffusion process that applies high-speed steel to both edges of the backing material, which increases the contact area by 170 percent. Bi-metal blades have a new tooth profile that generates more (but smaller) chips: this reduces frictional heat that is generated during the cutting application, which will enhance overall performance.

Part Number	Description	Teeth Per Inch	Quantity
FINE			
P4FS-6	Fine standard pitch	32	6
P4FS-20	Fine standard pitch	32	20
P4FS-50	Fine standard pitch	32	50
COARSE			
P4CS-6	Coarse standard pitch	24	6
P4CS-20	Coarse standard pitch	24	20
P4CS-50	Coarse standard pitch	24	50
EXTRA COARSE			
P4EV-6	Extra-coarse variable pitch	14 – 18	6
P4EV-20	Extra-coarse variable pitch	14 – 18	20
P4EV-50	Extra-coarse variable pitch	14 – 18	50



Air Finishing Tools



Ingersoll Rand has the industry's most complete line of air finishing tools. Sanders, polishers, and buffers come in a variety of models from traditional styles for heavy material removal to the newest models for excellent control and brilliant surfaces. All Ingersoll Rand finishing tools are designed for long-life and swirl-free finishes.

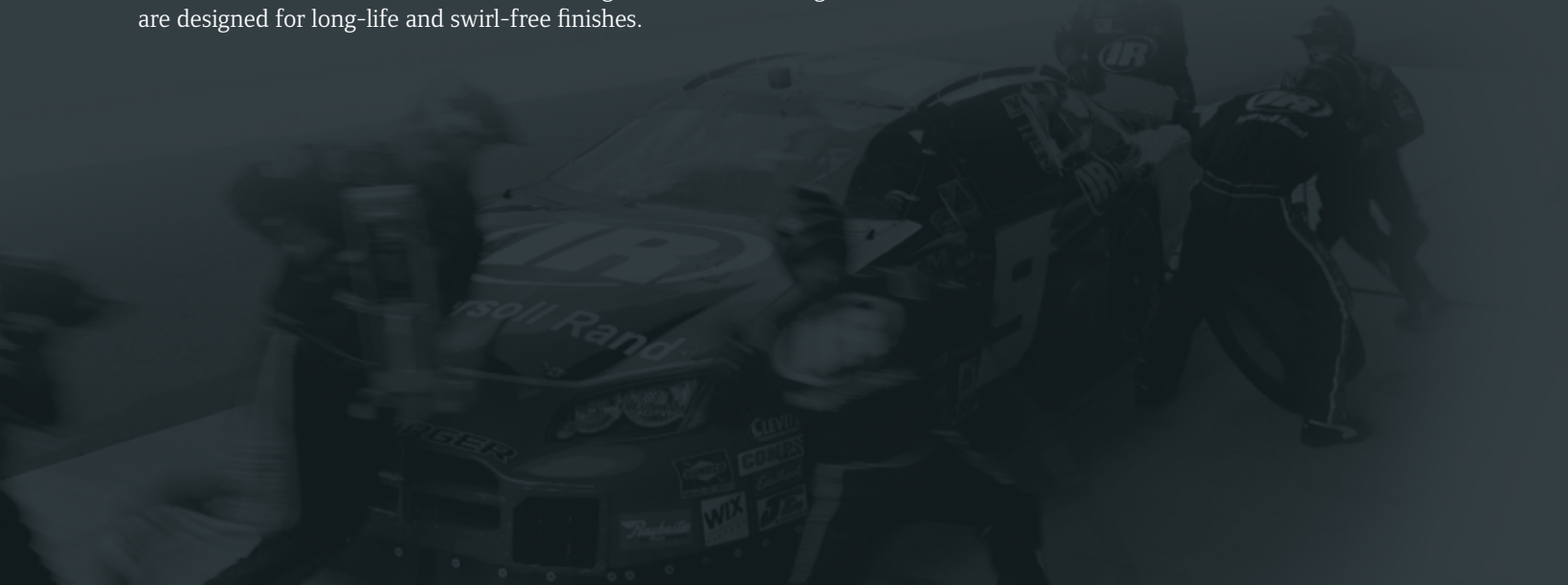

Air Finishing Tools

Model	Free Speed rpm	Rated Power hp (kW)	Pad Size in (mm)	Weight lb (kg)	Average Air Consumption cfm (L/min)	Average Air Consumption @ Load cfm (L/min)	Sound Pressure / Power dBA	Chuck Size in (mm)	Air Inlet NPTF in	Min Hose Size in (mm)
327*	22,000	0.5 (0.38)	N/A	1.6 (.73)	15 (425)	28 (793)	90.9 / 103.9	3/8" (10)	1/4"	3/8" (10)
327LS	3,000	0.5 (0.37)	N/A	1.13 (.51)	14 (396)	27 (765)	95 / 108	3/8" (10)	1/4"	3/8" (10)
312A	8,000	0.3 (0.22)	3-2/3" x 6-3/4" (93 x 171)***	4.6 (2.09)	9 (255)	12 (340)	94.1 / 107.1	N/A	1/4"	3/8" (10)
317A	18,000	N/A	5" (127)	2.3 (1.04)	12 (340)	25 (708)	96.5 / 109.5	N/A	1/4"	3/8" (10)
315	3,000**	N/A	2-3/4" x 17-1/2" (70 x 445)***	6.6 (2.99)	8 (226)	9 (255)	93.3 / 106.3	N/A	1/4"	3/8" (10)

*Not pictured. **1" length strokes per minute. ***Rectangular pad size.

327LS

Low-speed Air Tire Buffer

Designed for convenience, the many features of the 327LS make it an ideal tool for every tire shop. The quick-change chuck, built-in regulator, and lever-style throttle make patchwork, roughing areas for recapping, and cleaning tire moldings a breeze.

- Trigger design with lock-off feature allows for easy operation and protection from accidental start-up
- Piped-away exhaust (included) directs air away from work area and operator
- Convenient hanger keeps tool within easy reach



312A

Orbital Air Sander — 3-2/3" x 6-3/4" Pad

The 312A air orbital sander has a free speed up to 8,000 rpm to make fast work of smoothing fiberglass, wood, and body filler, and to take care of any sanding job on paint, metal, and fiberglass. Plus, you can run the 312A with one hand, using the compact, contoured palm-grip.

- Balanced ball bearing construction
- Automatic release throttle lever with positive stop action
- Built-in regulator for positive speed control



317A

High-speed Air Sander — 5" Pad

For small jobs and hard-to-reach places, the 317A is an economical high-speed sander ideal for light sanding, feather edging, and rust removal.

- Easy to handle, compact, and lightweight
- Built-in power regulator
- Comes with two backing pads; one is 3", and the other is 5" (stackable)



315

Twin-piston Straight-line Air Sander — 2-3/4" x 17-1/2" Pad

The twin-piston design keeps extra power in reserve to prevent stalling and tackle sanding jobs like smoothing down body filler or shaping and leveling large, flat surfaces.

- 3,000 reciprocating strokes per minute
- Quick-action paper clamps
- Smooth, reliable power



Straight-line Sanding Pads



Constructed with non-metallic material to reduce side strap wear, our straight-line sanding pads are designed specifically for the Ingersoll Rand 315 straight-line sander. See pages 57 and 58 for our full line of finishing tool accessories.

Model	Free Speed rpm	Rated Power hp (kW)	Pad Diameter in (mm)	Weight lb (kg)	Output	Average Air Consumption cfm (L/min)	Average Air Consumption @ Load cfm (L/min)	Sound Pressure / Power dBA	Air Inlet NPTF in	Min Hose Size in (mm)
311A	12,000	0.25 (0.191)	6" (150)	4.2 (1.91)	5/16" – 24 Thread	4 (113)	17 (481)	85.6 / 98.6	1/4"	3/8" (10)
328B	825	0.25 (0.191)	8" (203)	4.7 (2.13)	N/A	4 (113)	16 (453)	90.45 / 93.7	1/4"	3/8" (10)
313A	5,000	0.5 (0.37)	7" (175)	4.5 (2.04)	5/8" – 11 Thread	8 (226)	29 (651)	99.3 / 112.3	1/4"	3/8" (10)
314A*	2,500	0.4 (0.30)	7" (175)	4.5 (2.04)	5/8" – 11 Thread	8 (226)	29 (623)	97.3 / 110.3	1/4"	3/8" (10)
318A	2,800	1 (0.764)	7" (175)	4.5 (2.04)	5/8" – 11 Thread	6 (170)	21 (595)	90.5 / 103.5	1/4"	3/8" (10)
319A*	5,000	N/A	7" (175)	4.5 (2.04)	5/8" – 11 Thread	6 (170)	20 (566)	90.8 / 103.8	1/4"	3/8" (10)
MINI AIR FINISHING TOOLS										
3128K	15,000	0.2 (0.15)	3" (76.2)	1.1 (0.5)	1/4" – 20 Thread	2.06 (58)	14.7 (416)	84.2 / 96.9	1/4"	3/8" (10)
3129K	6,000	0.3 (0.22)	3" (76.2)	1.3 (0.6)	1/4" – 20 Thread	2.21 (62)	19.85 (561)	83.5 / 94.5	1/4"	3/8" (10)

*314 air angle sander and 319A polisher / buffer not pictured.

311A

Dual-action Quiet Air Sander — 6" Pad

A built-in silencer muffles noise as you work with this economical dual-action sander. It's a quality sander used for feather edging, metal preparation, and finish work on body filler. And its dual-action pad motion produces swirl-free finishes.

- Low vibration
- Balanced ball bearing construction
- Adjustable built-in regulator for positive speed control



328B

Gearred Orbital Air Sander — 8" Pad

The smooth strength and power of this air-gearred orbital sander lets you remove heavy material and body filler on large, flat surfaces leaving a clean, swirl-free finish.

- Dual-action pad motion (5/32" orbit)
- Long-life, low-vibration performance
- Balanced ball bearing construction



313A

Angle Air Sander — 7" Pad

With up to 5,000 rpm free speed, you can work faster on light and heavy sanding jobs, including roughing body filler, removing rust, and smoothing welds.

- Heavy-duty motor handles tough jobs
- Lightweight, only 4.5 lb
- Ball bearing construction for long life



318A

Vertical Air Polisher / Buffer — 7" Pad

Buff and polish all painted surfaces easily. This compact, lightweight vertical polisher / buffer gives you the results you want. The variable speed control lever throttle helps eliminate paint burning. Comes complete with a 7" backing pad.

- Long tool life from the planetary gear reduction feature
- Plenty of power from the 1 hp motor
- Handle exhaust directs air away from work area



3128K

Mini Random Orbital Sander Kit

- Delivers swirl-free finishes when feather edging, removing rust, preparing metal surfaces, or smoothing welds
- Durable ball-bearing construction ensures smooth power delivery
- Kit includes 71-piece hook-and-loop discs



Sands smoothly, leaving no swirl marks behind

3129K

Mini Polisher Kit

- Free speed of 6,000 rpm delivers the same performance of polishers twice the size
- Double-sided, adjustable speed settings provide variability for a broader range of applications
- Kit includes 4-piece hook-and-loop pads



Ideal for a smooth, professional finish

Air Finishing Tools

Model	Free Speed rpm	Rated Power hp (kW)	Pad Diameter in (mm)	Orbit Diameter in (mm)	Weight lb (kg)	Average Air Consumption cfm (L/min)	Average Air Consumption @ Load cfm (L/min)	Sound Pressure / Power dBA	Air Inlet NPTF in	Min Hose Size in (mm)
4151	12,000	0.2 (0.15)	6" (152)	3/16" (5)	1.92 (.87)	8 (226)	15.5 (439)	78 / 91	1/4"	5/16" (8)
4151-5*	12,000	0.2 (0.15)	5" (127)	3/16" (5)	1.92 (.87)	8 (226)	15.5 (439)	78 / 91	1/4"	5/16" (8)
4151-HL*	12,000	0.2 (0.15)	6" (152)	3/16" (5)	1.92 (.87)	8 (226)	15.5 (439)	78 / 91	1/4"	5/16" (8)
4151-2*	12,000	0.2 (0.15)	6" (152)	3/16" (5)	1.92 (.87)	8 (226)	15.5 (439)	78 / 91	1/4"	5/16" (8)
4152	12,000	0.2 (0.15)	6" (152)	3/32" (2.5)	1.92 (.87)	8 (226)	15.5 (439)	78 / 91	1/4"	5/16" (8)
4152-HL*	12,000	0.2 (0.15)	6" (152)	3/32" (2.5)	1.92 (.87)	8 (226)	15.5 (439)	78 / 91	1/4"	5/16" (8)

*Not pictured.

NOTE: HL models include a hook-and-loop pad.

4151

Vacuum-ready Random Orbital Air Sander

This vacuum-ready, low-vibration model produces an ultra high-quality finish and connects easily to central or portable vacuum systems. The 4151 extracts dust and particles through and around the pad, keeping foreign matter away from the motor. The vacuum sanding pad features a unique design with large 1/2" holes for efficient operation. Virtually all dust is instantly channeled away from the work.

- 12,000 rpm free speed for swirl-free finishes
- Durable, lightweight composite design weighs less than 2 lb
- Lubrication-free motor



4152

Vacuum-ready Random Orbital Air Sander

The 4152 sets a new standard in elite automotive finish work. This fine 3/32" orbit sander helps users achieve high-quality paint finishes. The 4152 utilizes a precision ground counterbalance to reduce vibration. The lubrication-free motor eliminates the worry of exhaust contaminants harming the work surface.

- 12,000 rpm free speed for swirl-free finishes
- Durable, lightweight composite design weighs less than 2 lb
- Lubrication-free motor



Vacuum Kits



Keep your work surface and area clean with our Jet-Vac dust extraction system and accessories. See page 57 for more information. Turn to page 58 for all other major components and accessories.

Vacuum Kits and Accessories

Influenced by jet engine technology, the Ingersoll Rand Jet-Vac dust extraction system sucks up more air than it takes to actually run the tool. Perfect for use with our sanders.

Part Number	Description	For Use With
JET-VAC CONVERSION KITS		
4151JV	Jet-Vac conversion kit	4151, 4152 Series, Cyclone Standard, Cyclone Select, CycloVAC sanders
49977*	5" Jet-Vac conversion kit	4151, 4152 Series, Cyclone Standard, Cyclone Select, CycloVAC sanders
49978*	6" Jet-Vac conversion kit	4151, 4152 Series, Cyclone Standard, Cyclone Select, CycloVAC sanders

*Not pictured.

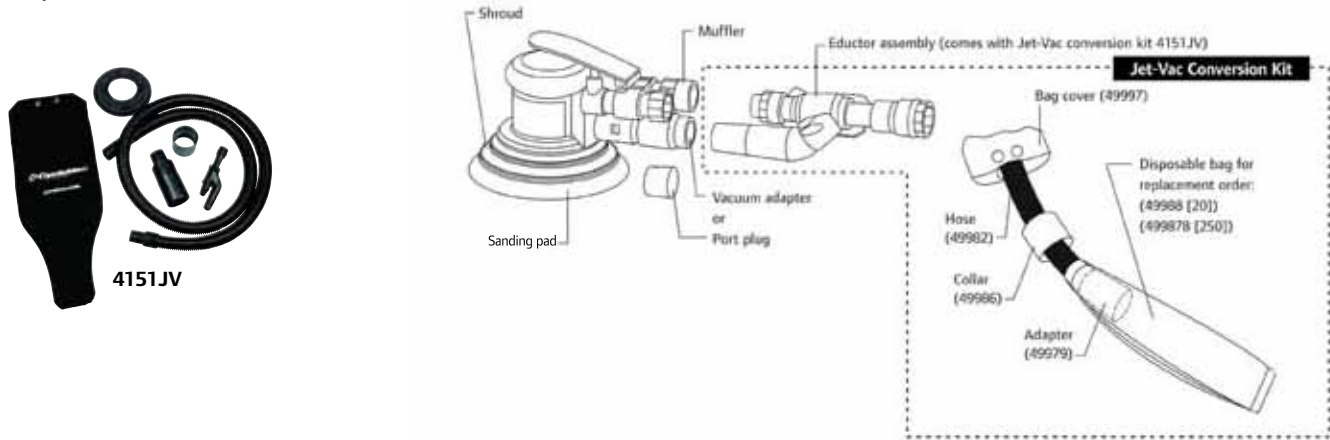

Part Number	Description	For Use With
JET-VAC ACCESSORIES		
49600*	6' (1.8 m) hose equipped with molded 1" ID cuffs at each end	4151, 4152 Series, Cyclone Standard, Cyclone Select, CycloVAC sanders
49973	Disposable vacuum bag (single)	4151, 4152 Series, Cyclone Standard, Cyclone Select, CycloVAC sanders
49997	Bag cover	4151, 4152 Series, Cyclone Standard, Cyclone Select, CycloVAC sanders
355-402*	Dust collection bag	4151, 4152 Series, Cyclone Standard, Cyclone Select, CycloVAC sanders
49979	Vacuum adapter	4151, 4152 Series, Cyclone Standard, Cyclone Select, CycloVAC sanders
49982	Vacuum hose	4151, 4152 Series, Cyclone Standard, Cyclone Select, CycloVAC sanders
49986*	Vacuum hose collar	4151, 4152 Series, Cyclone Standard, Cyclone Select, CycloVAC sanders
49987*	Disposable vacuum bags (250 pack)	4151, 4152 Series, Cyclone Standard, Cyclone Select, CycloVAC sanders
49988*	Disposable vacuum bags (20 pack)	4151, 4152 Series, Cyclone Standard, Cyclone Select, CycloVAC sanders

*Not pictured.



4100 Series Major Components and Accessories

Model	Description
NON-VACUUM PADS 3/8"	
49879-1	6" vinyl
49094-1	5" vinyl
49877-1	5" duck
VACUUM PADS 3/8"	
49099-1	6" petal pattern
49694	6" hook-and-loop
49096-1	5" petal pattern
VACUUM ADAPTER FOR MODEL 3154	
4151-809	Vacuum adapter
SHROUDS	
48266-1	Short (standard on 4151)
48878	Long
JET-VAC VACUUM BAGS	
49997	Jet-Vac dust collection bag (external)
49988	Disposable bags (20 pack)
49987	Disposable bags (250 pack)
JET-VAC CONVERSION KIT	
4151JV	6" pad 48878 – (1) 6" shroud 49976 – (1) eductor assembly 49973 – (3) disposable bags 49979 – (1) bag adapter 49997 – (1) cloth bag cover 49982 – (1) hose 49986 – (1) collar
SERVICE KIT (FOR PREVENTIVE MAINTENANCE)	
30131-2	IR49837 pad wrench (included with every tool)
SPANNER WRENCH	
44548	Use to remove the lock ring securing the motor assembly

Model	Diameter	Description
BACKING PADS FOR MODELS 313, 314, 318, 319		
313A-825-7	7"	Standard-duty – rigid backing pad
6130A	7"	Heavy-duty – flexible backing pad
DUAL-ACTION BACKING PADS FOR MODELS 310 AND 311		
310-825-6	6"	Standard-duty – firm pad for medium to heavy stock removal, cloth backed
311A-825-6	6"	Standard-duty – vinyl pad
6120A	6"	Heavy-duty – firm edge for firm support, cloth back
6121A	6"	Heavy-duty – soft edge for medium support, cloth back
6122A	5"	Heavy-duty – firm edge for firm support, cloth back
6123A	5"	Heavy-duty – soft edge for medium support, cloth back
DUAL-ACTION BACKING PAD FOR MODEL 328		
328A-826	8"	Standard-duty – pad assembly
POLISHING PAD FOR MODELS 314, 318, OR ANY POLISHER WITH A 5/8"-11 SPINDLE		
6135A	8"	2" thick polyester foam
STRAIGHT LINE SANDING PAD FOR MODEL 315		
315-39	N/A	Non-metallic material; fits similar brands of straight-line sanders

The full range of Ingersoll Rand sanding, backing, and polishing pads will help you complete every sanding, polishing, and grinding job to your satisfaction.

315-39 Straight-line Sanding Pads

For use with model 315. Non-metallic material reduces side strap wear caused by metallic sanding pads. Fits other similar brands of straight-line sanders.



6135A Polishing Pads

Polishing pads have 8" diameter, 2" thick polyester foam. For use with models 314, 318, or any polisher with a 5/8"-11 spindle.



317-825 Backing Pads

For use with model 317, one each 3", 4", and 5" backing pads.



Air Drills and Screwdrivers



Ingersoll Rand air drills have industrial-grade chucks and keyless chuck versions that are extra-tough for drilling, sawing, valve guide reaming, cylinder honing, and wire brushing. They are powerful, efficient, and durable with smooth, quiet operation.



Air Drills and Screwdrivers

Model	Chuck Size in (mm)	Free Speed rpm	Rated Power hp (kW)	Net Weight lb (kg)	Overall Length in (mm)	Average Air Consumption cfm (L/min)	Average Air Consumption @ Load cfm (L/min)	Sound Pressure / Power dBA	Air Inlet NPTF in	Min Hose Size in (mm)
3/8" CHUCK DRILL										
7802A	3/8" (10)	2,000	0.5 (0.38)	2.4 (1.09)	7.8" (198)	4 (113)	20 (566)	83 / 94	1/4"	3/8" (10)
7802RA	3/8" (10)	2,000	0.5 (0.38)	2.5 (1.13)	6.4" (163)	4 (113)	26 (736)	82 / 93	1/4"	3/8" (10)
7802RAKC	3/8" (10)	2,000	0.5 (0.38)	2.5 (1.13)	6.4" (163)	4 (113)	26 (736)	82 / 93	1/4"	3/8" (10)
1/2" CHUCK DRILL										
7803A	1/2" (13)	500	0.5 (0.38)	3.2 (1.45)	9" (229)	4 (113)	21 (595)	83 / 94	1/4"	3/8" (10)
7803RA*	1/2" (13)	400	0.5 (0.38)	3.3 (1.5)	8.7" (221)	4 (113)	27 (765)	83 / 94	1/4"	3/8" (10)
7803RAKC*	1/2" (13)	400	0.5 (0.38)	3.3 (1.5)	8.7" (221)	4 (113)	27 (765)	83 / 94	1/4"	3/8" (10)

*Not pictured.

7802A

Air Drill

With its industrial-grade 3/8" chuck, this economical choice includes high-quality features for general drilling and hole-sawing jobs. The planetary gear reduction balances the load on bearings and gears for increased tool life.

- Variable speed throttle
- Lightweight, compact drill



7802RA

Reversible Air Drill

Use this economical, high-quality 3/8" drill for all your general purpose drilling, honing, reaming, and hole-sawing. With its reversible 0.5 hp motor, you can also drive and remove screws — including backing out tight screws without a struggle.

- Reversible motor with a quick reverse lever
- Variable speed throttle for starting holes easily
- Smooth, lightweight, compact drill

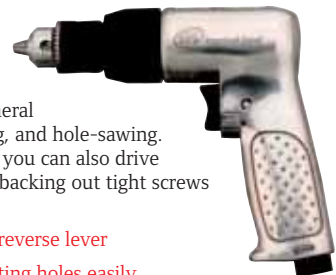

7802RAKC

Reversible Air Drill / Keyless Chuck

With its industrial-grade 3/8" chuck, this economical choice includes high-quality features for general drilling and hole-sawing jobs. The planetary gear reduction balances the load on bearings and gears for increased tool life.

- Variable speed throttle
- Lightweight, compact drill
- Keyless chuck



7803A

Air Drill

Here's the economical choice for power — a high-quality air drill designed for drilling, hole-sawing, cylinder honing, and any other job that calls for a 1/2" size. Its quality features for long life include the industrial-grade 1/2" chuck, ball and needle bearing construction, and double-reduction planetary gearing.

- No-load speed of 500 rpm
- Auxiliary side handle

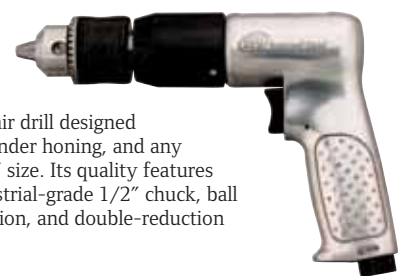

Drill Bits

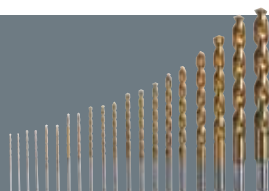

No matter what your drilling needs may be, count on Ingersoll Rand for the bits required to get the job done. Our full line of bits can be found on page 80. Additional air drill and screwdriver accessories can be found on page 62.

Model	Free Speed rpm	Chuck Size in (mm)	Rated Power hp (kW)	Net Weight lb (kg)	Overall Length in (mm)	Average Air Consumption cfm (L/min)	Average Air Consumption @ Load cfm (L/min)	Sound Pressure / Power dBA	Air Inlet NPTF in	Min Hose Size in (mm)
1/4" MINI TOOL DRILL / DRIVER KIT										
7804K	1,800	N/A	N/A	1.71 (0.78)	7-1/4" (184)	1.92 (54)	17.5 (495)	83.6 / 94.6	1/4"	3/8" (10)
3/8" CHUCK — RIGHT ANGLE DRILL										
7807R	1,800	3/8" (10)	0.33 (0.25)	2.5 (1.13)	8.1" (206)	4 (113)	17 (481)	89 / 102	1/4"	3/8" (10)
1/4" CHUCK SCREWDRIVER										
371	1,800	1/4" hex	0.44 (0.33)	2.54 (1.15)	7.4" (188)	4 (113)	29 (821)	78 / 91	1/4"	3/8" (10)

7804K

Mini 1/4" Drill / Driver Kit

- Double-sided, adjustable speed settings provide variability for a broader range of applications
- Double-bearing construction for longer life, impressive balance, and reduced vibration
- Kit includes 22-piece drill bit and driver set



Hard-hitting 5-vane motor delivers smooth and robust performance

7807R

3/8" Angle Reversible Drill

The 7807R is an excellent choice for service work requiring a compact, low-profile angle head. It's a durable, reliable tool for drilling in all types of materials, including sheet metal, wood, and composites.

- Durable Jacobs multi-craft chuck
- Reversible, with convenient control
- Precision machine gearing ensures maximum power transfer and durability



371

Reversible Pistol-grip Screwdriver

The 371 is an excellent choice for soft-draw applications. This tool is well-suited for service work on HVAC systems, instrument panels, and trim components. It delivers reliable performance for driving sheet metal, self-tapping, and wood screws.

- Positive action clutch, for full torque throughout rundown
- Convenient one-handed operation, with reverse control at trigger
- Variable speed throttle for easy starts



Replacement Chucks and Chuck Keys

Model	Capacity in (mm)	Thread in (mm)	Chuck Key Catalog Number	Tool Number
728-99-KC5	3/8" (10)	3/8" x 24" (10 x 610)	Keyless	7802, 7802R, 7811
7802-99	3/8" (10)	3/8" x 24" (10 x 610)	R000B2J70-J253	7802, 7802R, 7811R
728-99-KC8	1/2" (13)	3/8" x 24" (10 x 610)	Keyless	7806, 7803, 7803R, 7816R
7803-99	1/2" (13)	3/8" x 24" (10 x 610)	7803-253	7803, 7803R, 7816R



Comfort Grips

Part Number	Description	For Use With
DRILL GRIPS		
CG-6X8	6" x 8" sheet of comfort grip material	All tools

- Cut to size to fit your tool

Drill Boots

Part Number	Description	For Use With
PROTECTIVE TOOL BOOTS		
7802-BOOT	Air drill boot with Ingersoll Rand logo printed on red boot	7802A, 7802RA, 7802RAKC
7803-BOOT	Air drill boot with Ingersoll Rand logo printed on red boot	7803A, 7803RA, 7803RAKC

Drill/Hex Bits

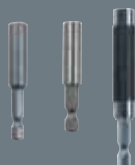

No matter what your drilling needs may be, count on Ingersoll Rand for the bits required to get the job done. We offer a variety of drill bits and hex driver bits designed specifically for our cordless drills/drivers. See pages 78-81.

Air Hammers



Ingersoll Rand air hammers are designed so you can let the tool do the work, whether it's cutting, punching, chipping, or scraping. Each air hammer comes with a coil spring retainer for fast and easy chisel changes. You can also buy a five-piece chisel set, or get an Ingersoll Rand air hammer kit, which includes both the hammer and the chisel set.



Air Hammers

Model	Shank Opening in (mm)	bpm @ 90 psi	Bore Diameter in (mm)	Stroke Length in (mm)	Weight lb (kg)	Length in (mm)	Average Air Consumption cfm (L/min)	Average Air Consumption @ Load cfm (L/min)	Sound Pressure / Power dBA	Air Inlet NPTF in	Min Hose Size in (mm)
115	0.401" (10.1)	5,000	3/4" (19)	1-5/8" (41)	2.6 (1.18)	6.1" (155)	2 (57)	14 (396)	101.3 / 114.3	1/4"	3/8" (10)
115K	0.401" (10.1)	5,000	3/4" (19)	1-5/8" (41)	2.6 (1.18)	6.1" (155)	2 (57)	14 (396)	101.3 / 114.3	1/4"	3/8" (10)
116	0.401" (10.1)	3,500	11/16" (17.5)	2-5/8" (67)	3.4 (1.54)	7.8" (198)	3 (85)	15 (425)	104.4 / 117.4	1/4"	3/8" (10)
116K*	0.401" (10.1)	3,500	11/16" (17.5)	2-5/8" (67)	3.4 (1.54)	7.8" (198)	3 (85)	15 (425)	104.4 / 117.4	1/4"	3/8" (10)
117	0.401" (10.1)	2,000	11/16" (17.5)	3-1/2" (89)	4.1 (1.86)	9.9" (251)	3 (85)	14 (396)	103.5 / 116.5	1/4"	3/8" (10)
117K*	0.401" (10.1)	2,000	11/16" (17.5)	3-1/2" (89)	4.1 (1.86)	9.9" (251)	3 (85)	14 (396)	103.5 / 116.5	1/4"	3/8" (10)
121-K6	0.401" (10.1)	3,000	3/4" (19)	2-9/32" (58)	3.5 (1.59)	7.63" (194)	3 (85)	15 (425)	98.3 / 111.3	1/4"	3/8" (10)
121/Q*	0.401" (10.1)	3,000	3/4" (19)	2-9/32" (58)	3.5 (1.59)	7.63" (194)	3 (85)	15 (425)	98.3 / 111.3	1/4"	3/8" (10)
132*	0.401" (10.1)	1,725	9/16" (14)	4" (102)	3.4 (1.54)	8.5" (216)	3 (85)	11 (311)	N/A	1/4"	5/16" (8)

*Not pictured.

115

Air Hammer

This powerful yet economical high-speed air hammer is designed for light exhaust system work and general cutting, chipping, and scraping.

- Up to 5,000 blows per minute
- Alloyed steel barrel and heat-treated piston for longer life
- Built-in power regulator and trigger control

Also available: 115K includes 5-piece chisel kit.



116

Air Hammer

The economical air hammer for fast cutting action, especially for medium exhaust system, panel cutting, and general repair work.

- Up to 3,500 blows per minute
- Handles a range of cutting applications
- Longer-life alloyed steel barrel and heat-treated piston

Also available: 116K includes 5-piece chisel kit.



117

Air Hammer

An economical air hammer with a longer piston stroke, this tool is designed for exhaust work, bolt cutting, and front-end work. The trigger control and a built-in power regulator give you full control of the speed and power.

- Longer-stroke piston
- Alloyed steel barrel and heat-treated piston for longer life
- Up to 2,000 blows per minute

Also available: 117K includes 5-piece chisel kit.

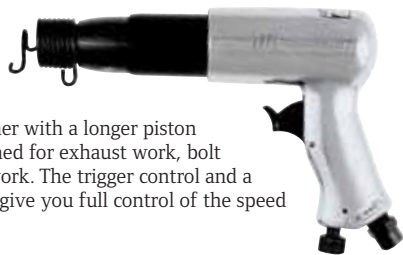

121-K6

Air Hammer Kit

Make fast work of body panel crimping and cutting, bushing, driving, shearing, and general front-end work with this air hammer.

- 3,000 blows per minute
- Tough 1-piece alloy barrel
- Kit includes blow-molded case and 6-piece chisel set

Also available: 121/Q tool only.



9500 Chisel Set



A five-piece chisel set in a plastic pouch with 0.401" shank diameters to match your Ingersoll Rand air hammer. See page 65 for more information about this set and all our other chisels.

Needle Scaler

Model	Needle Quantity	Needle Size in (mm)	bpm @ Free Speed rpm	Bore Diameter in (mm)	Stroke Length in (mm)	Weight lb (kg)	Length in (mm)	Average Air Consumption cfm (L/min)	Average Air Consumption @ Load cfm (L/min)	Sound Pressure / Power dBA	Air Inlet NPTF in	Min Hose Size in (mm)
125	19	1/8" (3.2)	4,600	1" (25)	1-1/8" (28.6)	6.22 (2.82)	18.3" (465)	8 (226)	15 (425)	99.6 / 112.6	1/4"	5/16" (8)

125

Needle Scaler

For surface preparation work involving the cleaning or removal of paint, rust, dirt, or weld slag, the 125 is a durable, dependable, and economical solution.

- 19 needles
- Each needle measures 1/8"
- 4,600 blows per minute at free speed



125 Chisels

Model	Type	Width* in (mm)
PF2200-391	Blank	N/A
PF2200-392	Chisel	3/4" (19)
PF2200-393	Wide chisel	1-3/8" (35)
PF2200-394	Angle chisel	1-3/8" (35)
PF2200-390	Scraper	2" (50)
PF2200-390-3	Scraper	3" (75)
PF2200-3231	Round nose	1/4" (6)
PF2200-3232	Cape chisel	1/4" (6)

*All chisels are 7" in length.



Replacement Needle Set

Part Number	Description	Width* in (mm)
PF2219-22-19	Needle set	1/8" (3)

*All chisels are 7" in length.

Comfort Grips

Part Number	Description	For Use With
HAMMER GRIPS		
CG-6X8	6" x 8" sheet of comfort grip material	All tools

- Cut to size to fit your tool

Spring Retainers

Model	Description	For Use With
115-183	Spring retainer	115, 116, 117
AVC10-183A	Spring retainer	121, 132
AVC1-83	Beehive retainer	121, 132

Replacement Chisels

Model	Description
9500	5-piece hammer chisel set
9505	Hammer spring retainer, 2 pack
9510	Quick change hammer retainer for 115, 116, 117
9512	Quick change hammer retainer for 121, 132
950011	Tailpipe cut-off tool
950012	Slotted panel cutter
950013	Rivet and bolt cutter
950014	Pneumatic scraper
950015	Pneumatic hammer chisel
950016	Pneumatic cold chisel, 8"
950017	Pneumatic cold chisel
950018	Muffler and tailpipe remover
950019	Pneumatic ball joint separator

Mini Air Tools



Our mini tools range in size between 5" and 7-1/4" in length, making them small enough to easily fit in the palm of almost anyone's hand, and ideal for tight spaces and fine detail finish work. They perfectly complement our existing lineup of full-size automotive maintenance and repair tools — delivering the power, versatility, and durability that you have come to expect from Ingersoll Rand.

The mini tools feature composite housings with ergonomic textured grips to provide comfort and exceptional resistance to grease, chemicals, and extreme temperatures. They also feature lightweight, pistol-grip designs with thumb-actuated switches engineered for balance and one-handed operation, variable-speed triggers, and a complete accessory package.

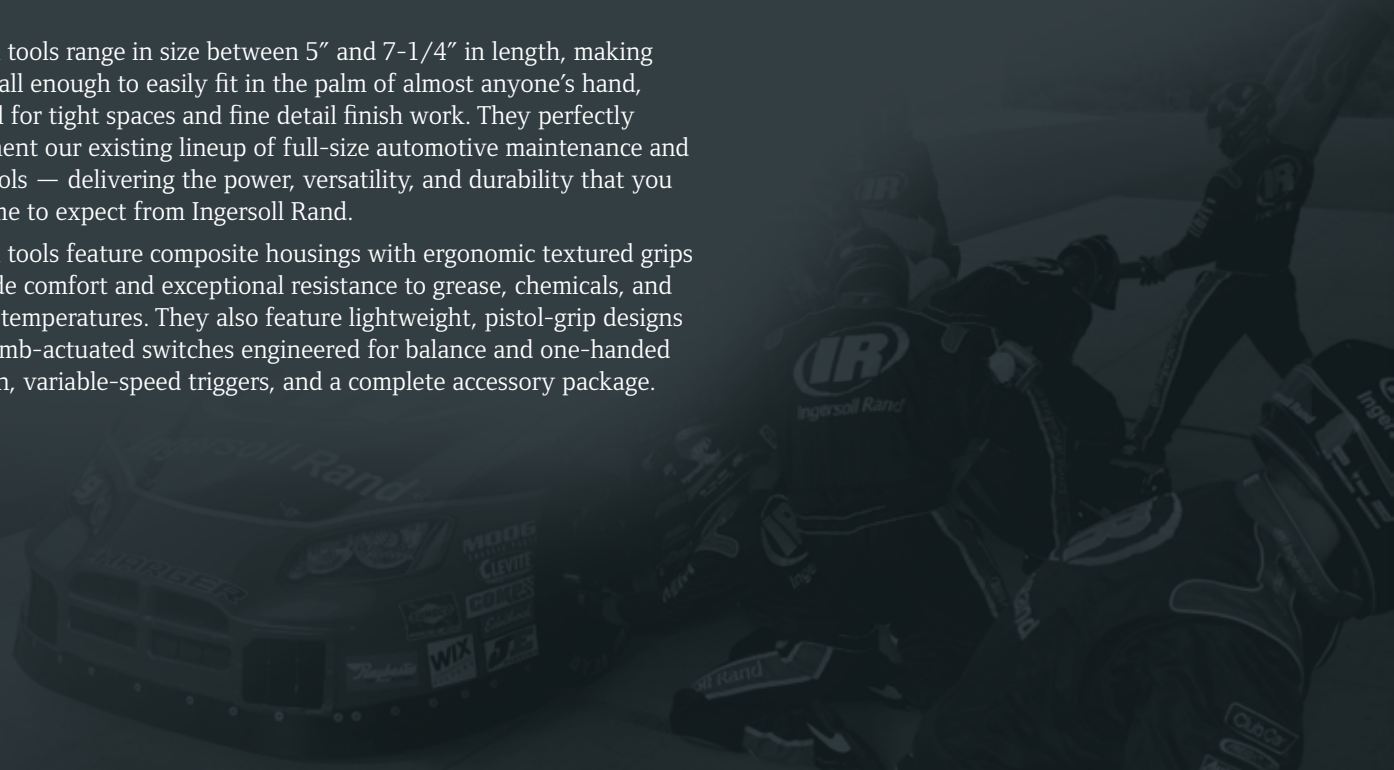

Mini Tools

2101K Specifications

Drive – in	1/4"
Torque Range – ft-lb (Nm)	25 – 40 (34 – 54)
Max Reverse Torque – ft-lb (Nm)	50 (68)
Free Speed – rpm	11,000
Blows Per Minute – bpm	1,250
Standard Bolt Capacity – in	5/16"
Net Weight – lb (kg)	1.37 (0.62)
Kit Weight – lb (kg)	3 (1.36)
Overall Length – lb (kg)	6-1/4"
Average Air Consumption – cfm	1.76
@ Load – cfm	18.17
Sound Pressure / Power – dBA	83.6 / 94.6
Air Inlet – in	1/4"
Min Hose Size – in	3/8"



**Fastens conveniently
in hard-to-reach
places**

2101K

Mini 1/4" Impactool Kit

- Hard-hitting 5-vane motor delivers smooth and robust performance
- Easily accessible forward / reverse switch for one-handed operation
- Kit includes 10-piece 1/4" socket set

7804K Specifications

Drive – in	1/4"
Torque – in-lbs (Nm)	22.5 (30.5)
Free Speed – rpm	1,800
Net Weight – lb (kg)	1.71 (0.78)
Kit Weight – lb (kg)	2.7 (1.22)
Overall Length – lb (kg)	7-1/4"
Average Air Consumption – cfm	1.92
@ Load – cfm	17.5
Sound Pressure / Power – dBA	83.6 / 94.6
Air Inlet – in	1/4"
Min Hose Size – in	3/8"



**Hard-hitting 5-vane
motor delivers smooth
and robust performance**

7804K

Mini 1/4" Drill / Driver Kit

- Double-sided, adjustable speed settings provide variability for a broader range of applications
- Double-bearing construction for longer life, impressive balance, and reduced vibration
- Kit includes 22-piece drill bit and driver set

3103K Specifications

Pad Size – in (mm)	2" and 3" (50.8 and 76.2)
Free Speed – rpm	15,000
Rated Power – hp	0.2
Net Weight – lb (kg)	0.99 (0.45)
Kit Weight – lb (kg)	2.7 (1.22)
Overall Length – in	5"
Average Air Consumption – cfm	2.07
@ Load – cfm	19.4
Sound Pressure / Power – dBA	84.9 / 95.9
Air Inlet – in	1/4"
Min Hose Size – in	3/8"



**Removes rough spots
quickly and easily**

3103K

Mini Surface Prep Grinder Kit

- Ball-bearing construction enhances durability and smooth power delivery
- Double-sided, adjustable speed settings provide variability for a broader range of applications
- Kit includes 14-piece 2" and 3" sanding discs

Mini Tools

3128K Specifications

Pad Size – in (mm)	3" (76.2)
Free Speed – rpm	15,000
Rated Power – hp	0.2
Net Weight – lb (kg)	1.1 (0.5)
Kit Weight – lb (kg)	2.81 (1.28)
Overall Length – in	5-1/2"
Average Air Consumption – cfm	2.06
@ Load – cfm	14.7
Sound Pressure / Power – dBA	84.2 / 96.9
Air Inlet – in	1/4"
Min Hose Size – in	3/8"

3129K Specifications

Pad Size – in (mm)	3" (76.2)
Free Speed – rpm	6,000
Rated Power – hp	0.3
Net Weight – lb (kg)	1.33 (0.6)
Kit Weight – lb (kg)	2.88 (1.31)
Overall Length – in	6"
Average Air Consumption – cfm	2.21
@ Load – cfm	19.85
Sound Pressure / Power – dBA	83.5 / 94.5
Air Inlet – in	1/4"
Min Hose Size – in	3/8"



Sands smoothly,
leaving no swirl
marks behind

3128K

Mini Random Orbital Sander Kit

- Delivers swirl-free finishes when feather edging, removing rust, preparing metal surfaces, or smoothing welds
- Durable ball-bearing construction ensures smooth power delivery
- Kit includes 71-piece hook-and-loop discs



Ideal for
a smooth,
professional
finish

3129K

Mini Polisher Kit

- Free speed of 6,000 rpm delivers the same performance of polishers twice the size
- Double-sided, adjustable speed settings provide variability for a broader range of applications
- Kit includes 4-piece hook-and-loop pads

Mini Tool Accessories

Part Number	Description
MINI POLISHER ACCESSORIES	
03H-PAD-HL	3" hook-and-loop backer pad (fits polisher and RO sander)
03F-SFTWL-6	3" hook-and-loop wool pad (for compounding)
03F-MEDFM-6	3" hook-and-loop waffle pad white (for compounding)
03F-SFTFM-6	3" hook-and-loop waffle pad yellow (for polishing)



3" hook-and-loop backer pad



3" hook-and-loop wool pad



3" hook-and-loop waffle pad, white



3" hook-and-loop waffle pad, yellow



6-piece box as shown

Part Number	Description	Grit
3" HOOK AND LOOP AO PAPER		
03H-040AO-50	3" hook-and-loop aluminum oxide disc	40
03H-080AO-50	3" hook-and-loop aluminum oxide disc	80
03H-100AO-50	3" hook-and-loop aluminum oxide disc	100
03H-120AO-50	3" hook-and-loop aluminum oxide disc	120
03H-180AO-50	3" hook-and-loop aluminum oxide disc	180
03H-220AO-50	3" hook-and-loop aluminum oxide disc	220
03H-240AO-50	3" hook-and-loop aluminum oxide disc	240
03H-320AO-50	3" hook-and-loop aluminum oxide disc	320
03H-360AO-50	3" hook-and-loop aluminum oxide disc	360
03H-400AO-50	3" hook-and-loop aluminum oxide disc	400
03H-500AO-50	3" hook-and-loop aluminum oxide disc	500
03H-800AO-50	3" hook-and-loop aluminum oxide disc	800



50-piece box as shown

IQ^V™ Series Cordless Tools

Specifically designed for the service and production industries, Ingersoll Rand IQ^V™ Series cordless tools deliver best-in-class power and durability, and are backed by our strong commitment to our customers. The same engineering that made our air tools the world's best now delivers cordless technologies that get the most out of every volt. We offer six revolutionary IQ^V batteries in both lithium-ion and nickel-cadmium chemistries, plus three voltage platforms. The IQ^V Series is also backed by the best warranty in the industry.

More than just cordless, *Ingersoll Rand* cordless

- First line of cordless tools specifically designed for the professional mechanic
- Delivers unmatched power, durability, and our commitment to enhance your productivity and satisfaction



Industry-leading durability

- Rugged internal mechanisms last up to five times longer than competition
- Metal-reinforced housings add strength for unmatched drop resistance
- Engineered composite housings for increased resistance against corrosive chemicals
- Built to hit hard — and take a beating — for years



IQ^V Grip batteries

- Patent-pending twist-to-lock battery connection
- Eliminates wear and tear common with competitive battery mounts



Smart voltage

- Integrated microprocessor circuitry delivers optimized charging and power
- IQ^V lithium-ion and nickel-cadmium batteries can be used with any IQ^V Series tool



Intelligent charging

- IQ^V charger works with all voltages of both our lithium-ion and nickel-cadmium batteries
- Automatically detects battery chemistry and voltage to optimize charging
- Renew feature eliminates memory effect in nickel-cadmium batteries
- Extends recharge life — up to three times longer than the competition

The best cordless tools, backed by the best warranty

IQ^V™ WARRANTY

1 Year
Hassle-Free
Tool & Charger
Replacement

2 Year
or 1,000
Recharges
Battery Limited Warranty

3 Year
Limited Warranty
Tools & Chargers
3 year does not include
ratchets, grinders and
cut-off tools

REGISTRATION REQUIRED (irtools.com)
See irtools.com for Official Terms & Conditions
May vary by tool and country



- Free extended warranty with registration
- Easy Internet registration or toll-free hotline
- Door-to-door replacement service within 72 hours

Cordless Impacttools

Model	Drive Size	Drive Type	Max Torque ft-lb (Nm)	Usable Torque Range ft-lb (Nm)	Speed rpm	bpm	Weight lb (kg)	NiCad Weight lb (kg)	Li-Ion Weight lb (kg)	Length in (cm)	Sound Pressure / Power dBA	Voltage volts
W040	1/4"	Quick change	40 (54)	1 – 32 (2 – 43)	2,200	2,500	1.8 (0.8)	2.9 (1.3)	2.7 (1.2)	7 (17.8)	90 / 101	7.2
W040SQ*	3/8"	Square	40 (54)	1 – 32 (2 – 43)	2,200	2,500	1.8 (0.8)	2.9 (1.3)	2.7 (1.2)	7 (17.8)	90 / 101	7.2
W040P*	3/8"	Square pin	40 (54)	1 – 32 (2 – 43)	2,200	2,500	1.8 (0.8)	2.9 (1.3)	2.7 (1.2)	7 (17.8)	90 / 101	7.2
W150	3/8"	Square	150 (203)	25 – 130 (34 – 176)	2,200	3,000	3.2 (1.5)	5 (2.3)	4.7 (2.1)	8.2 (20.9)	90 / 101	14.4
W150QC*	1/4"	Quick change	150 (203)	25 – 130 (34 – 176)	2,200	3,000	3.2 (1.5)	5 (2.3)	4.7 (2.1)	8.2 (20.9)	90 / 101	14.4
W150P*	3/8"	Square pin	150 (203)	25 – 130 (34 – 176)	2,200	3,000	3.2 (1.5)	5 (2.3)	4.7 (2.1)	8.2 (20.9)	90 / 101	14.4
W175*	1/2"	Quick change	175 (237)	25 – 130 (34 – 176)	2,200	3,000	3.2 (1.5)	5 (2.3)	4.7 (2.1)	8.2 (20.9)	90 / 101	14.4
W175P*	1/2"	Square pin	175 (237)	25 – 130 (34 – 176)	2,200	3,000	3.2 (1.5)	5 (2.3)	4.7 (2.1)	8.2 (20.9)	90 / 101	14.4
W360	1/2"	Square	360 (488)	25 – 280 (33 – 379)	1,650	2,200	4.8 (2.2)	7.2 (3.3)	6.2 (2.8)	9 (22.8)	90 / 101	19.2
W360P*	1/2"	Square pin	360 (488)	25 – 280 (33 – 379)	1,650	2,200	4.8 (2.2)	7.2 (3.3)	6.2 (2.8)	9 (22.8)	90 / 101	19.2
W360-2*	1/2"	Square 2" extension	360 (488)	25 – 280 (33 – 379)	1,650	2,200	4.8 (2.2)	7.2 (3.3)	6.2 (2.8)	9 (22.8)	90 / 101	19.2

*Not pictured.

Batteries and chargers sold separately.

W040

QC 1/4" Cordless Impactool

With its 40 ft-lb of maximum reverse torque, the W040 delivers the right amount of power for tasks involving small fasteners. Its industrial-grade quick change hex lets you change bits easily and enables bind-free operation.

- Compact for easy access in confined spaces
- 40 ft-lb maximum reverse torque
- Lightweight — only 2.7 lb with lithium-ion battery



W150

3/8" Cordless Impactool*

An optimized impact mechanism enables the W150 to deliver 150 ft-lb of maximum reverse torque with only 14.4 volts. Like its counterpart, the W360, this Impactool features a steel-reinforced frame where tools are most vulnerable to drop damage.

- The most powerful and durable cordless impact in its class
- 150 ft-lb maximum reverse torque
- Lightweight — only 4.7 lb with lithium-ion battery



*Sockets and drill bits not included.

W360

1/2" Cordless Impactool

It's hard to believe the W360 is a cordless tool. At 360 ft-lb of maximum reverse torque, the W360 produces more power with less voltage, size, and weight than competitive models.

- Pound-for-pound, the most powerful cordless Impactool in the world
- 360 ft-lb maximum reverse torque
- Lightweight — only 6.2 lb with lithium-ion battery



Cordless Boots







Our IQ^V Series cordless tool boots absorb vibrations and protect the tool from dirt, grime, wear and tear, and accidental external damage. Our boots and other cordless accessories can be found on pages 77 – 81.

IQ^V Series Cordless Kits

Top-selling Ingersoll Rand cordless tools are now available in convenient hard case kits for a quick and easy way to start your new IQ^V cordless tool collection. Individual tools, batteries, chargers, and accessories are available for purchase through our IQ^V Choice program — offering a cost-effective way to expand or upgrade your IQ^V tool collection later on.



IMPACTTOOLS™	DESCRIPTION	Kit Includes*	
		1 Battery	2 Batteries
	1/4" 7.2V Impact Driver Kit with Li-Ion battery, charger and case	W040-KL1	W040-KL2
	3/8" 14.4V Impact Wrench Kit with Li-Ion battery, charger and case	W150-KL1	W150-KL2
	1/2" 19.2V Impact Wrench Kit with 1 Li-Ion battery, charger and case	W360-KL1	W360-KL2
RATCHETS	DESCRIPTION	MODELS	
	1/4" 7.2V Ratchet Kit with Li-Ion battery, charger and case	R140-KL1	R140-KL2
	3/8" 7.2V Ratchet Kit with Li-Ion battery, charger and case	R145-KL1	R145-KL2
	3/8" 14.4V Ratchet Kit with Li-Ion battery, charger and case	R380-KL1	R380-KL2
	1/2" 14.4V Ratchet Kit with 1 Li-Ion battery, charger and case	R385-KL1	R385-KL2
DRILLS	DESCRIPTION	MODELS	
	1/4" Keyed Chuck 7.2V Drill/Driver Kit with Li-Ion battery, charger and case	D040-KL1	D040-KL2
	1/2" Keyless Chuck 14.4V Drill/Driver Kit with Li-Ion battery, charger and case	D550-KL1	D550-KL2
	1/2" Keyless Chuck 19.2V Drill/Driver Kit with Li-Ion battery, charger and case	D650-KL1	D650-KL2
GRINDERS	DESCRIPTION	MODELS	
	14.4V Straight Die Grinder Kit with Li-Ion battery, charger and case	GS25-KL1	GS25-KL2
	14.4V Right Angle Grinder Kit with Li-Ion battery, charger and case	GR25-KL1	GR25-KL2
	14.4V Cutoff Tool Grinder Kit with Li-Ion battery, charger and case	GC25-KL1	GC25-KL2

*All kits include universal charger (7.2V - 19.2V)

Cordless Drill Drivers

Model	Ideal Stall Torque in-lb (Nm)	Speed rpm	Weight lb (kg)	NiCd Weight lb (kg)	Li-Ion Weight lb (kg)	Length in (cm)	Sound Pressure / Power dBA	Voltage volts
D040	40 (4.52)	1,100	1.7 (.77)	2.71 (1.23)	2.5 (1.14)	6.9 (176)	N/A	7.2
D550	550 (62)	360 / 1,300	4.8 (2.2)	5.4 (3.3)	4.3 (1.9)	9.2 (23.3)	67 / 78	14.4
D650	650 (73)	360 / 1,300	5.4 (2.5)	7.2 (3.3)	4.5 (2)	9.2 (23.3)	67 / 78	19.2

Sold separately: BC10 battery charger; BL144 Li-Ion and N144 NiCad batteries (for D550); BL192 Li-Ion and N192 NiCd batteries (for D650).

D040

1/4" Mini Drill

The D040 1/4" mini drill is the perfect solution for all of your tight access drilling applications. Under 7" long, this tool can fit into even the smallest areas with ease. The 1/4" keyed chuck ensures bit retention and more reliable performance. Weighing only 2.5 lb, the D040 is extremely ergonomic and ideal for drilling small holes and screwdriving.

- Smallest and lightest cordless drill in its class
- Variable speed trigger ensures maximum control and higher motor durability
- Drop-resistant structural housing protects against breakage

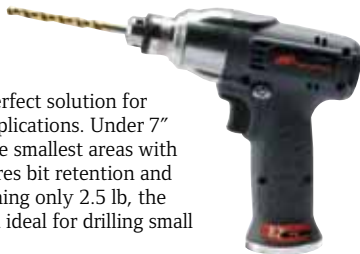

D550

Cordless Drill / Driver

Weighing a mere 4.3 lb with a lithium-ion battery, the D550 drill / driver provides 550 in-lb of stall torque. The D550 also features a 17-position ball clutch for convenient over-tightening control.

- 550 in-lb ideal stall torque
- All-metal industrial ratchet lock chuck
- Lightweight — only 4.3 lb with 14.4-volt lithium-ion battery



D650

Cordless Drill / Driver

The D650 features best-in-class weight and power, and features an industrial-duty ratchet chuck that eliminates slipping bits and is faster and easier than competitive equipment to tighten. The D650 delivers 650 in-lb of stall torque, and weighs an impressive 4.5 lb with a lithium-ion battery.

- 650 in-lb ideal stall torque
- All-metal industrial ratchet lock chuck
- Lightweight — only 4.5 lb with 19.2 volt lithium-ion battery



Drill Bits

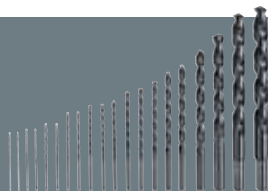

We offer a variety of drill bits and hex driver bits designed specifically for our cordless drills/drivers. Our complete line of cordless accessories can be found on pages 69 – 73.

Cordless Ratchets

Model	Type	Anvil Size in	Voltage volts	Useable Torque Range ft-lb (Nm)	Max Torque ft-lb (Nm)	Free Speed rpm	Weight – tool only lb (kg)	NiCad Weight lb (kg)	Li-Ion Weight lb (kg)	Length in (mm)	Switch Type	Sound Pressure / Power dBA
R140	Mini	1/4"	7.2	5 – 25 (7 – 34)	25 (34)	225	2 (0.9)	3.1 (1.4)	2.9 (1.3)	10.7 (272)	Variable speed	74.9
R145*	Mini	3/8"	7.2	5 – 25 (7 – 34)	25 (34)	225	2 (0.9)	3.1 (1.4)	2.9 (1.3)	10.7 (272)	Variable speed	74.9
R380	Standard	3/8"	14.4	10 – 60 (14 – 81)	70 (94)	225	2.8 (1.3)	4.6 (2)	4.3 (1.9)	12.4 (315)	Variable speed	80.8
R385*	Standard	1/2"	14.4	10 – 60 (14 – 81)	70 (94)	225	2.8 (1.3)	4.6 (2)	4.3 (1.9)	12.4 (315)	Variable speed	80.8

*Not pictured
Sold separately: BC10 battery charger; BL072 and BL144 Li-Ion batteries; N072 and N144 NiCd batteries.

R140

Cordless 1/4" Mini Ratchet

Delivers impressive performance for its size — a mere 2.9 lb with a lithium-ion battery.

- 25 ft-lb of maximum torque
- Impressive mobility for hard-to-reach tasks
- Compatible with all 7.2-volt IQ^v lithium-ion and nickel-cadmium batteries



R380

Cordless 3/8" Standard Ratchet

Delivers the perfect combination of power, durability, and convenience. At 70 ft-lb maximum torque, the R380 is more powerful than any other ratchet in its class.

- Advanced head design — built with the proven 107XPA pneumatic ratchet head
- Proprietary motor control with variable speed
- Compatible with all 14.4-volt IQ^v batteries including lithium-ion and nickel-cadmium



Cordless Grinders

Model	Type	Collet Size in	Power hp	Free Speed rpm	Voltage volts	Weight (tool only) lb (kg)	NiCd Weight lb (kg)	Li-Ion Weight lb (kg)	Length in (mm)	Switch Type
GS25	Straight	1/4"	0.35	27,500	14.4	1.5 (0.67)	3.3 (1.5)	2.9 (1.4)	9 (230)	Variable speed
GR25	Right angle	1/4"	0.35	20,000	14.4	1.8 (0.82)	3.6 (1.7)	3.3 (1.5)	9.5 (240)	Variable speed

Sold separately: BC10 battery charger; BL144 Li-Ion and N144 NiCd batteries.

GS25

Cordless Straight Grinder

Versatility without a cord or hose, 0.35 hp motor, battery compatibility, variable speed, and an exclusive motor control that prevents motor damage from heat or stalling.

- 27,500 rpm free speed
- Same proven head and collet as our 3108 pneumatic die grinder
- 2.9 lb with lithium-ion battery



GR25

Cordless Angle Grinder

Outstanding performance and portability for light-duty grinding. For use with accessories up to 2".

- 0.35 hp motor delivers impressive power
- Same proven angle head and collet as our 3102 pneumatic die grinder
- Compatible with all 14.4-volt IQ^v batteries including lithium-ion and nickel-cadmium



Cut-off Tool

Model	Type	Collet Size in	Power hp	Free Speed rpm	Voltage volts	Weight Tool Only lb (kg)	NiCd Weight lb (kg)	Li-Ion Weight lb (kg)	Length in (mm)	Switch Type
GC25	Cut-off	3"	0.35	25,000	14.4	1.8 (0.82)	3.6 (1.6)	3.3 (1.5)	9.53 (242)	Variable speed

GC25

3" Cut-off Tool

The GC25 3" cut-off tool combines power, durability, and portability to make one of the most versatile tools in your box. The only 3" cordless cut-off tool available, the GC25 is perfect for light-duty cutting jobs including muffler work, bolt cutting, exhaust, and sheet metal work.

- Powerful 0.35 hp motor
- Variable speed trigger provides feather control
- Microprocessor-controlled motor protection



IQV TECHNOLOGY

Task Light

Model	19.2-volt Li-Ion Weight lb (kg)	Length in (mm)	19.2-volt Battery Runtime
TL10	2.3 (1.04)	8.3 (211)	10 hours



TL10

High Intensity LED Task Light

The TL10 high intensity LED task light utilizes state-of-the-art LED technology to provide the highest quality, brightest light available. An onboard microprocessor allows the TL10 to work with all IQV batteries. The high-output LED bulb offers up to 50,000 hours of bulb life and up to 10 hours runtime (BL192).

- Works with all IQV batteries
- 160° pivoting, low-profile head provides lighting versatility
- High-quality 4-watt LED bulb lasts up to 50,000 hours

IQV™ WARRANTY

1 Year
Hassle-Free
Tool & Charger
Replacement

2 Year
or 1,000
Recharges
Battery Limited Warranty

3 Year
Limited Warranty
Tools & Chargers
3-year does not include ratchets, grinders and cut-off tools.

REGISTRATION REQUIRED (irtools.com)
See irtools.com for Official Terms & Conditions
May vary by tool and country

IR Ingersoll Rand

Batteries sold separately.
3-year warranty is not applicable for ratchets and grinders.

IQV Warranty

- 1-year hassle-free tool and charger replacement
- 2-year (or 1,000 recharges) battery limited warranty
- 3-year limited warranty tools and chargers

IQV Choice

- All tools sold individually — no more bulky combo kits
- Buy only what you need
- Flexibility to upgrade and expand
- Lowest long-term cost of ownership

Commitment to Cordless

- Full line of cordless tools for service and production applications
- Distinctive products, designed for specific customer needs
- Complete line of Ingersoll Rand accessories optimized for our tools
- More IQV Series cordless tools coming soon

Cut-off Wheels



See page 44 for our Cut-off Wheels.

Batteries, Chargers, and Accessories



Batteries and Chargers

The revolutionary IQ^V cordless power system features nickel-cadmium and lithium-ion batteries — available in 7.2-volt, 14.4-volt, and 19.2-volt capacities. All of our cordless tools are compatible with both battery chemistries. Our patented IQ^V Grip twist-to-lock battery mount design eliminates wear and tear common to other types of mount clips and slides.

Our digitally controlled BC10 charger can be used with every one of our batteries. Once a battery is inserted into the charger, it automatically determines chemistry, voltage, and condition, thereby optimizing the charge process.

Nickel-cadmium Batteries

Part Number	Description
N072	7.2-volt battery
N144	14.4-volt battery
N192	19.2-volt battery

Features and Benefits

- IQ^V microprocessor-controlled battery technology optimizes battery performance to make sure you get the most power out of every volt
- Renew feature refreshes nickel-cadmium batteries to like-new capacity and extends recharge life up to three times
- Patented twist-to-lock technology firmly holds battery in place — never duct tape your battery to your tool again!

IQ^V TECHNOLOGY



Lithium-ion Batteries

Part Number	Description
BL072	7.2-volt battery
BL144	14.4-volt battery
BL192	19.2-volt battery

Features and Benefits

- Industry-leading lithium-ion cell technology blows the competition away with over 1,000 real recharges
- Requiring only one cell to match the power in four nickel-cadmium / nickel-metal hydride cells, Ingersoll Rand lithium-ion batteries offer up to 35% less weight than the nickel-cadmium version
- Patented twist-to-lock technology firmly holds battery in place — never duct tape your battery to your tool again!



Cordless
Power Tools

Battery Charger

Part Number	Description
BC10	Battery charger

Features and Benefits

- Allows the charger to charge all IQ^V batteries including all voltages of nickel-cadmium and lithium-ion
- Fully charges most batteries in less than 45 minutes
- Renew feature deep-cycle charges nickel-cadmium batteries — eliminating memory effect, restoring to like-new capacity



Battery Analyzer

Part Number	Description
BT-IQV	Battery analyzer

Features and Benefits

- Gives instant access to status information stored on IQ^V batteries for determining condition
- Takes the guesswork out of determining when to replace the battery
- Easy connection to PC via USB and easy-to-use software



Accessory Cases

Ingersoll Rand accessory cases are specifically designed to solve a number of common problems experienced by automotive and industrial professionals. These heavy-duty ballistic nylon cases are conveniently portable, easy to use, and can withstand the abuse any shop environment can dish out. The carriers are available in both book and flap styles.

- Feature magnetic buttons for one-handed bit access
- Metal-reinforced grommets for hanging
- Belt loops for greater mobility
- Unlike plastic cases, these won't damage sensitive work surfaces or break if dropped



1/4" Hex Bit Sets

Our quick change driver bits and related accessories are the perfect complement to our compact 1/4" cordless Impactool (all sets come in ballistic nylon accessory cases).

Part Number	Description
HXNSK-10E	10-PIECE 2" POWER BIT SAE NUT SETTER KIT
Sizes	5/32", 3/16", 7/32", 1/4" 9/32", 5/16", 11/32", 3/8", 7/16", 1/2"
Features	<ul style="list-style-type: none"> • Quick-change hex drive for easy removal • Top of the line magnetics for increased bit retention • Full assortment of sizes to be used on any project
HXNSK-9M	9-PIECE 2" POWER BIT METRIC NUT SETTER KIT
Sizes	5.5 mm, 6 mm, 7 mm, 8 mm, 9 mm, 10 mm, 11 mm, 12 mm, 13 mm
Features	<ul style="list-style-type: none"> • Quick-change hex drive for quick and easy removal • Top of the line magnetics for increased bit retention • Full assortment of sizes to be used on any project
HXALK-9E	9-PIECE 2" MAGNETIC POWER BIT SAE ALLEN BIT KIT
Sizes	1/16", 5/64", 3/32", 7/64", 1/8", 9/64", 5/32", 3/16", 1/4"
Features	<ul style="list-style-type: none"> • Quick-change hex drive for quick and easy removal • Magnetic bit increases strength of hold on screw • Made of high-quality, industrial-grade steel



Cordless Accessories

1/4" Hex Bit Sets (continued)

Part Number	Description
HXALK-9M	9-PIECE 2" MAGNETIC POWER BIT METRIC ALLEN BIT KIT
Sizes	1.5 mm, 2 mm, 2.5 mm, 3 mm, 4 mm, 5 mm, 6 mm, 7 mm, 8 mm
Features	<ul style="list-style-type: none"> • Quick-change hex drive for quick and easy removal • Magnetic bit increases strength of hold on screw • Made of high-quality, industrial-grade steel
HXSQS-2*	2-PIECE POWER BIT SOCKET ADAPTER SET
Sizes	1/4" square drive adaptor, 3/8" square drive adaptor
Features	<ul style="list-style-type: none"> • Allows addition of sockets to a driver • Magnetic tip allows for great hold on sockets
HXCMK-20	20-PIECE POWER BIT COMBO KIT
Pieces	(2) #1 Phillips, #2 Phillips, #3 Phillips 5/32", 3/16", 1/4", 7/32" power Allen bits #6, #8, #10 slotted driver bits T8, T9, T10, T15, T20, T25, T30 Torx Res driver bits (2) #2 Phillips 3" long
Features	<ul style="list-style-type: none"> • Assortment of bits for completion of all tasks • 3" Phillips bit for hard-to-reach places • Made of high-quality industrial-grade steel
HXCMK-30	30-PIECE POWER BIT COMBO KIT
Pieces	(2) #1 Phillips, (2) #2 Phillips, (2) #3 Phillips 1/8", 9/64", 5/32", 3/16", 1/4", 7/32" Allen bits #6, (2) #8, #10 slotted driver bits T8, T9, T10, T15, T20, T25, T30, T40 Torx Res driver bits 1/4" and 3/8" magnetic square drive adaptors 1/4", 3/8", 5/16" magnetic nut setters #2 Phillips 3" long
Features	<ul style="list-style-type: none"> • Heat-treated, shock-resistant tool steel for optimum durability • Assortment of bits for completion of all tasks • Manufactured using the most advanced processes
HXTXK-11	11-PIECE POWER BIT TORX DRIVE SET
Sizes	T5, T6, T7, T8, T9, T10, T15, T20, T25, T30, T40
Features	<ul style="list-style-type: none"> • Tamper-resistant • Quick-change hex drive for easy removal • Made of high-quality industrial-grade steel
BHS-3*	3-PIECE BIT HOLDER SET
Sizes	2" and 3" magnetic bit holders, 3" drive guide
Features	<ul style="list-style-type: none"> • Drive guide for easy screw insertion • Magnetic tips for quick change of standard bits • Heat-treated, shock-resistant tool steel for optimum durability

*This set does not include case. Comes in blister pack.



Cordless Accessories



Drill / Driver Bit Sets

No matter what your drilling needs may be, count on Ingersoll Rand for the bits you require to get the job done. We offer a variety of drill bits and hex driver bits designed specifically for our cordless drills / drivers. (All drill / driver bit sets include case.)

Black Oxide Bits

These bits are designed for general-purpose, heavy-duty drilling through carbon and alloy steels, aluminum, soft-cast iron, wood, wood composites, and plastics.

Part Number	Description
DBKBO-20E	20-PIECE FRACTIONAL JOBBER LENGTH DRILL BIT SET
Sizes	(2) 1/16", (2) 5/64", (2) 3/32", (2) 7/64", (2) 1/8", 9/64", 5/32", 11/64", 3/16", 7/32", 1/4", 5/16", 3/8", 7/16", 1/2"
Features	<ul style="list-style-type: none"> • High-quality black oxide finish • Fully ground for superior quality • Made with high-speed steel



Titanium-coated Bits

These bits dramatically reduce heat and friction, making them last many times longer than other bits. Titanium bits are designed for repetitive heavy-duty drilling through common stainless steels, carbon and alloy steels, aluminum, soft-cast iron, wood, wood composites, and plastics.

Part Number	Description
DBKTI-20E	20-PIECE TITANIUM FRACTIONAL JOBBER LENGTH DRILL BIT SET
Sizes	(2) 1/16", (2) 5/64", (2) 3/32", (2) 7/64", (2) 1/8", 9/64", 5/32", 11/64", 3/16", 7/32", 1/4", 5/16", 3/8", 7/16", 1/2"
Features	<ul style="list-style-type: none"> • Titanium coating for increased protection • Fully ground for superior quality • Made with high-speed steel



Cobalt Bits

These bits withstand high temperature drilling applications for extended periods of time. They're designed for heavy-duty drilling through hardened stainless steels, cast iron, and titanium.

Part Number	Description
DBKCB-20E	20-PIECE COBALT FRACTIONAL JOBBER LENGTH DRILL BIT SET
Sizes	(2) 1/16", (2) 5/64", (2) 3/32", (2) 7/64", (2) 1/8", 9/64", 5/32", 11/64", 3/16", 7/32", 1/4", 5/16", 3/8", 7/16", 1/2"
Features	<ul style="list-style-type: none"> • Integrated cobalt for maximum protection and durability • Fully ground for superior quality



Part Number	Description
SDKTI-3E	3-PIECE STEP DRILL SET
Sizes	1/8" - 1/2" in 1/32" increments; 3/16" - 1/2" in 1/16" increments; 1/4" - 3/4" in 1/16" increments
Features	<ul style="list-style-type: none"> • 1/32" and 1/16" increments for accurately rounded and smooth holes • Titanium-coated life • Ideal for drilling repetitive holes in steel, copper, brass, plastic, Plexiglas®, and other materials
DDCMK-28E	28-PIECE DRILL / DRIVE BIT COMBO SET
Pieces	1/16", 3/32", 1/8", 5/32", 3/16", 7/32", 1/4", 3/8" fractional jobber length drill bits #6, #8 slotted driver bits T10, T15, T20, T25 Torx drill bits 1/8", 9/64", 5/32", 3/16", 1/4" Allen drill bits 2" magnetic bit holder 3/8" power bit magnetic square drive adaptor 1/4", 5/16", 3/8" power bit magnetic nut setter
Features	• Multiple drill bits and driver bits



Part Number	Description	For Use With
LIGHT HOLDER BOOTS		
W040-BOOT-LED	Premium boot with LED flashlight holder (kit includes LED flashlight)	W040
W150-BOOT-LED	Premium boot with LED flashlight holder (kit includes LED flashlight)	W150

Part Number	Description	For Use With
PROTECTIVE TOOL BOOTS		
W040-BOOT	Cordless Impactool boot with Ingersoll Rand logo printed on red boot	W040
W150-BOOT	Cordless Impactool boot with Ingersoll Rand logo printed on red boot	W150
W360-BOOT	Cordless Impactool boot with Ingersoll Rand logo printed on red boot	W360
D550-BOOT	Cordless drill boot with Ingersoll Rand logo printed on red boot	D550 and D650
D040-BOOT	Cordless mini drill boot and chuck key holder with Ingersoll Rand logo printed on red boot	D040



Tool Bags and Holsters

Ingersoll Rand tool bags are designed to help you transport your tools as easily and comfortably as possible. Constructed of double-lined ballistic nylon for durability, these bags also feature a padded shoulder strap and handle for increased comfort. Each bag contains ample room for tools as well as spacious inside and outside pockets for storing accessories. Ingersoll Rand tool bags come in three sizes to fit any need.

Ingersoll Rand Tool Bags and Holsters

Part Number	Description
TB1	16" tool bag
TB2	20" tool bag
TB3	25" tool bag
CDTHS	Small holster for D040 and W040
CDTHL	Large holster for D550, D650, W150, W360



Cordless Power Tools

Air Compressors and System Components



For more than 75 years, Ingersoll Rand has been the world leader in air compressors and air system accessories. We understand the needs and requirements for air systems and the business demands that you face every day. Rising energy costs and reduced margins require increased reliability and efficiency from not only your air compressor, but your entire air system. Simply stated, your air system is much more than an air compressor. It's the complete system — the piping, filters, dryers, drains, hoses, valves, and point-of-use tools.



Selecting an Air Compressor — FAQs

How will compressed air be used?

The type of work being performed is probably the most important factor in selecting a compressor.

Where will the compressor be located?

Indoors: heated environment to prevent air lines from freezing while providing sufficient ventilation to cool compressor where elevated temperatures may exist. Outdoors: protection against ambient environment and provisions for cold-weather starting.

How much pressure (psi) is needed?

Compressor discharge pressure must exceed the psi requirement of all pneumatic tools or equipment being operated.

How much airflow (cfm) is needed?

Cubic feet per minute (cfm) is the measure of airflow the compressor can create. The measurement cfm is stated in two different forms: piston displacement (pd) or actual cubic feet per minute (acfm). Always consider acfm, as it reflects the amount of useable compressed air.

What horsepower is required?

Horsepower is directly proportional to the cfm rating of the compressor. The higher the horsepower, the more air (cfm) the compressor can deliver. Do not rely solely on horsepower when specifying or selecting an air compressor.

What type and size of tank is needed?

The tank provides a reserve of air to meet peak flow and pressure demands. The larger the receiver, the more reserve available. Tanks are available in vertical and horizontal designs; configuration is dependent upon available floor space.



What are the electrical requirements?

Identify available incoming electrical service before specifying an air compressor. Always have a qualified electrician review electrical requirements.

Know Your Power Source

All residential and commercial buildings have 115 V / 60 Hz power. Many residential, commercial, and industrial buildings have 230 V / single-phase / 60 Hz power, but this should be confirmed. When electric power is not available, select a gas engine-driven compressor. Do not use a gas engine compressor indoors.



Rotary Screw Air Compressors

Rotary screw models compress air through two oil-flooded, intermeshed helical screws. This form of compression offers maximum efficiency at much higher air quality levels than reciprocating models with constant pressure capabilities. Rotary screw air compressors can operate 24/7, continuous-duty at extremely quiet noise levels compared to reciprocating compressors, and have up to five times the operating life.

- Low sound — operates at low sound levels of 64 to 69 dBA
- Closely maintained pressure delivers pulse-free air
- 9,000-hour / 2-year coolant — Ultra-Plus coolant offers superior separation for lower coolant make-up, and will not varnish or sludge; improved cooling characteristics reduce operating temperatures, improving the life of the airend



High-efficiency
Integrated Compression
Module



Rotary Screw
Airends

UP Series 5-15 HP

Model	Running Power hp	Tank Capacity gal	Airflow acfm	Discharge Pressure psi	Air NPT Outlet in	Package Dimensions in	Net Weight lb
UP6-5-125	5	80	18.5 @ 125 psi	125	3/4"	53.6" x 28.9" x 60.7"	925
UP6-5-150	5	80	16 @ 150 psi	150	3/4"	53.6" x 28.9" x 60.7"	925
UP6-7.5-125	7.5	80	28 @ 125 psi	125	3/4"	53.6" x 28.9" x 60.7"	925
UP6-7.5-150	7.5	80	25 @ 150 psi	150	3/4"	53.6" x 28.9" x 60.7"	925
UP6-10-125	10	80	38 @ 125 psi	125	3/4"	53.6" x 28.9" x 60.7"	925
UP6-10-150	10	80	34 @ 150 psi	150	3/4"	53.6" x 28.9" x 60.7"	925
UP6-15c-125	15	80	55 @ 125 psi	125	3/4"	53.6" x 28.9" x 60.7"	925
UP6-15c-150	15	80	50 @ 150 psi	150	3/4"	53.6" x 28.9" x 60.7"	925

Our 5-15HP UP Series rotary screw air compressors provide best-in-class performance in rotary screw technology. Each compressor package comes standard with 230 / 460-3-60 ODP electric motor, air-cooled aftercooler to reduce discharge air temperatures, full voltage motor starter that is mounted and wired (wired for 230-3-60 voltage standard), dual control (auto start and stop, constant speed control), low sound / full sheet metal enclosure, package pre-filter, 9,000-hour rated Ultra-Plus coolant, spin-on oil filter and separator element, A.S.M.E coded horizontal receiver tank with electric drain valve, and NEMA-1 electrical protection. These models operate at 64 to 69 dBA.

Recommended accessories:

- Installation kit (page 86)
- Maintenance kit (page 87)
- PolySep (page 90)
- PacE controller (page 88)



Rotary Screw Air Compressors

UP Series 5-15 HP Total Air System

Model	Running Power hp	Tank Capacity gal	Airflow acfm	Operating Pressure psi	Discharge Pressure psi	Air NPT Outlet in	Package Dimensions in	Net Weight lb
UP6-5TAS-125	5	80	18.5 @ 125 psi	125	115	3/4"	53.6" x 28.9" x 60.7"	1,000
UP6-5TAS-150	5	80	16 @ 150 psi	150	140	3/4"	53.6" x 28.9" x 60.7"	1,000
UP6-7.5TAS-125	7.5	80	28 @ 125 psi	125	115	3/4"	53.6" x 28.9" x 60.7"	1,000
UP6-7.5TAS-150	7.5	80	25 @ 150 psi	150	140	3/4"	53.6" x 28.9" x 60.7"	1,000
UP6-10TAS-125	10	80	38 @ 125 psi	125	115	3/4"	53.6" x 28.9" x 60.7"	1,000
UP6-10TAS-150	10	80	34 @ 150 psi	150	140	3/4"	53.6" x 28.9" x 60.7"	1,000
UP6-15cTAS-125	15	80	55 @ 125 psi	125	115	3/4"	53.6" x 28.9" x 60.7"	1,000
UP6-15cTAS-150	15	80	50 @ 150 psi	150	140	3/4"	53.6" x 28.9" x 60.7"	1,000

Are you looking to save space and installation cost by having a complete clean, dry air system in a single package? The UP Series 5-15 HP Total Air System (TAS) is an innovative solution to your compressed air needs. The TAS has the same features and benefits of the standard UP Series 5-15HP unit, but also comes standard with an Energy Star cycling refrigerated air dryer with stainless steel heat exchanger, integrated compressor and dryer controls for optimum operation, panel-mounted dew point indicator, dual filters (general purpose and high-efficiency) mounted and piped, single-point condensate drain system with electric drain (115-volt), and high-efficiency moisture separator. These models operate at 64 to 69 dBA.

- Two coalescing filters: general purpose and high-efficiency
- Cycling refrigerated air dryer
- Pre-piped, single-point condensate drain system
- Eliminates up to 80 percent of traditional installation cost of individual air treatment equipment
- Intelligent design separates temperature-sensitive components and air treatment center on "cool side" from heat generating air end on the "hot side"



Recommended accessories:

- Installation kit (page 86)
- Maintenance kit (page 87)
- PolySep (page 90)
- PacE controller (page 88)
- Package pre-filters (4 pack)

Start-up Kits



Ingersoll Rand start-up kits include all the parts needed to maintain your compressor for one year, plus the added protection of extended warranty coverage. Ingersoll Rand air compressor accessories can be found on pages 94 – 107.

Rotary Screw Air Compressors

UP Series 20-40 HP

Ultimate Reliability

Maximum Uptime

Ingersoll Rand is so confident in the performance of the UP-Series that we've extended the warranty to five years.

Fewer Connections

Smart integration eliminates leaks and pressure drops, maximizing reliability.

Ultimate Efficiency

More Air For Your Money

Industry-leading performance delivers more air for less horsepower, saving thousands of dollars per year on energy.

Smart, Energy-Efficient Controls

Eliminates wasteful unloaded running by unloading rapidly and by cycling the compressor on/off when not needed.

Ultimate Flexibility

Compact Footprint

Receiver mounting frees up valuable floor space and reduces installation costs.

Installation Close To Point-of-Use

Whisper-quiet operation allows for installation closer to point-of-use, reducing costs and ensuring a better, safer work environment.

Ultimate Productivity

Closely Maintained Pressure

Reducing discharge pressure and avoiding excessive pressure bands, increases downstream tool and equipment life.



UP6-20-40 HP

Model	Running Power hp	Tank Capacity gal	Airflow acfm	Discharge Pressure psi	Air NPT Outlet in	Package Dimensions in	Net Weight lb
UP6-20-125	20	120	83	125	1	77.5 x 36 x 71	1510
UP6-20-150	20	120	75	150	1	77.5 x 36 x 71	1510
UP6-25-125	25	120	102	125	1	77.5 x 36 x 71	1530
UP6-25-150	25	120	92	150	1	77.5 x 36 x 71	1530
UP6-30-125	30	120	125	125	1	77.5 x 36 x 71	1616
UP6-30-150	30	120	112	150	1	77.5 x 36 x 71	1616
UP6-40-115	40	baseplate	188	115	1 1/2	67.4 x 54.3 x 52.8	2326
UP6-40-125	40	baseplate	185	125	1 1/2	67.4 x 54.3 x 52.8	2326
UP6-40-150	40	baseplate	170	150	1 1/2	67.4 x 54.3 x 52.8	2326

Rotary Screw Air Compressors

UP Series 20-40 hp with Integrated Dryer

Advanced Packaging to Drive Reliability and Uptime

Smart Integration for 15-30 hp

- “Dry” air receiver mounted in a compact package lowers the cost of installation (optional floor mount also available).
- Integral air cooling with separate flow paths ensure cooling is achieved 100% of time that the compressor is running.
- Easy access to all compressor and air treatment components, promoting serviceability.
- Package pre-filter for longer component life and reduced maintenance cost.
- Simplified piping eliminates potential leaks.
- Single-point condensate drain system.



Smart Integration for 40 hp

- Floor mounted units only (a wide range of free-standing receivers are optionally available).
- Integrally cooled dryer module with separate cooling paths to achieve best overall efficiency and ensure cooling is achieved.
- Spacious design simplifies access and promotes serviceability.
- Package pre-filter for longer cooler life and reduced maintenance costs
- Simplified piping eliminates potential leaks.
- Single-point condensate drain system instead of separate points reduces installation cost.
- Segregated cooling compartment provides advanced cooling flow management and reduces noise level.

UP6-20-40 HP w/ Integrated Dryer Package

Model	Running Power hp	Tank Capacity gal	Airflow acfm	Discharge Pressure psi	Air NPT Outlet in	Package Dimensions in	Net Weight lb
UP6-20-125 w/ Integrated Dryer	20	120	83	125	1	77.5 x 36 x 72	1735
UP6-20-150 w/ Integrated Dryer	20	120	75	150	1	77.5 x 36 x 72	1735
UP6-25-125 w/ Integrated Dryer	25	120	102	125	1	77.5 x 36 x 72	1776
UP6-25-150 w/ Integrated Dryer	25	120	92	150	1	77.5 x 36 x 72	1776
UP6-30-125 w/ Integrated Dryer	30	120	125	125	1	77.5 x 36 x 72	1862
UP6-30-150 w/ Integrated Dryer	30	120	112	150	1	77.5 x 36 x 72	1862
UP6-40-115 w/ Integrated Dryer	40	baseplate	188	115	1 1/2	67.4 x 54.3 x 52.8	2326
UP6-40-125 w/ Integrated Dryer	40	baseplate	185	125	1 1/2	67.4 x 54.3 x 52.8	2326
UP6-40-150 w/ Integrated Dryer	40	baseplate	170	150	1 1/2	67.4 x 54.3 x 52.8	2326

Single and Two-stage Air Compressors

Single-stage

Single-stage models compress air to a final pressure in one stroke. They generally are used for pressures between 70 and 90 psi (maximum pressure to 135 psi).

- Oversized belt wheel provides reliable design and cooler operation
- Durable cast-iron cylinders, heads, and frame are designed for continuous operation and extended pump life
- Extended service intervals — Ingersoll Rand synthetic lubricant provides 2,000-hour oil change intervals (four times longer than mineral-based lubricants)
- High-efficiency stainless steel finger valves are simple, efficient, and easy to maintain
- Manual thermal overload protection of the motor — no starter required
- Sight glass makes it easy to check oil level



Two-stage

A two-stage model compresses air to an intermediate pressure in the first stage, removes heat compression through an intercooler, and compresses air to a final pressure in a second compression stage. Two-stage compressors are more efficient and are generally used for pressures above 100 psi (maximum pressure to 175 psi).

- Two-stage design provides 175 psi operation
- Removable cylinders are easy to repair and provide even 360° cooling, which helps eliminate hot spots
- One-piece connecting rod for fewer wear parts
- Low oil level switch provides constant protection
- Centrifugal unloader ensures loadless starts, providing maximum starter protection
- Finned copper intercooler runs cooler in even the most demanding conditions
- Overhung crankshaft is precision-balanced to run smoothly and quietly
- Splash lubrication is simple and reliable



Single-stage Air Compressors

Model	Running Power hp	Voltage DC volts	Tank Capacity gal	Airflow @ 90 psi acfm	Max psi	Air NPT Outlet in	Package Dimensions L x W x H in	Net Weight lb
SINGLE-STAGE UNIT — TWIN STACK								
DD2T2	2	115-1-60	4.5 twin	4.4	125	3/8"	21" x 15" x 17"	58
SINGLE-STAGE UNITS — GARAGE MATE								
P1.5IU-A9	2	115-1-60	20 vert	5.2	135	3/8"	22" x 23" x 43"	200
SS3F2-GM	2	115-1-60	30 horiz	5.7	135	3/8"	46" x 25" x 35"	185

Twin-stack

Single-stage — Portable

The Ingersoll Rand twin-stack air compressor is designed to provide power, durability, and portability on the jobsite. Built to last, this oil-lube compressor with durable cast-iron cylinders is designed for 100% continuous-duty applications. The twin-stack includes a 1/4" universal coupler, conveniently mounted regulator and pressure gauge, 4.5-gallon twin tanks, All-Season Select® lubricant, and a power cord.

- Lightweight and compact
- Durable cast-iron construction
- Extended pump life — double the life of similar oil-free products



DD2T2

Garage Mate

Single-stage — Portable

Description to come

- XXXXX



P1.5IU-A9



SS3F2-GM

Single-stage Air Compressors

Model	Running Power hp	Voltage DC volts	Engine	Tank Capacity gal	Airflow @ 90 psi acfm	Max psi	Air NPT Outlet in	Package Dimensions L x W x H in	Net Weight lb
WHEELBARROW SINGLE-STAGE — ELECTRIC-DRIVEN									
SS3J2-WB	2	115 / 230-1-60	N/A	8 twin	5.7	135	3/8"	43" x 18" x 25"	175
SS3J3-WB	3	230-1-60	N/A	8 twin	11.3	135	3/8"	43" x 18" x 25"	175
WHEELBARROW SINGLE-STAGE — GASOLINE-DRIVEN									
SS3J5.5GB-WB	5.5	N/A	Briggs & Stratton	8 twin	11.8	135	3/8"	43" x 18" x 25"	175
SS3J5.5GH-WB	5.5	N/A	Honda	8 twin	11.8	135	3/8"	43" x 18" x 25"	175

Model	Compressor Pump	Running Power hp	Voltage DC volts	Engine	Tank Capacity gal	Airflow @ 90 psi acfm	Max psi	Air NPT Outlet in	Net Dimensions L x W x H in	Net Weight lb
AIR SLED SINGLE-STAGE UNITS — ELECTRIC-DRIVEN										
SS3J3-AS	Single-stage	3	230-1-60	N/A	8 twin	11.3	135	3/8"	38" x 18" x 26"	174
AIR SLED UNITS — GASOLINE-DRIVEN										
SS3J5.5GH-AS	Single-stage	5.5	N/A	Honda	8 twin	11.8	135	3/8"	38" x 19" x 27"	177
2340S9GH-AS	Two-stage	9	N/A	Honda	8 twin	14.3	175	1/2"	42" x 21" x 32"	312

Wheelbarrow

Single-stage — Portable

Ingersoll Rand electric and gas engine-driven wheelbarrow air compressors are lightweight with a low-profile design to provide maximum maneuverability. Built to last, these cast-iron, oil-lube compressors are designed for 100% continuous-duty applications. Includes pressure switch, regulator, and gauge; two quick disconnects to power multiple tools; and twin 8-gallon capacity tanks. Electric model features a belt drive to provide quiet operation (76 dBA), a 6' power cord, and dual voltage (2-hp model only). Where electric power is not readily available, the gas-driven model is powered by either a 5.5-hp Honda or Briggs & Stratton high-performance engine.

- Designed for maximum maneuverability on the jobsite
- Durable cast iron construction
- 100% continuous-duty for tough applications
- Includes two quick disconnects to power multiple tools



SS3J5.5GH-WB

Air Sled

Single- and Two-stage — Portable

Ingersoll Rand electric and gas engine-driven air sled compressors feature a rugged frame support to meet the rigorous demands of field handling. Base package includes pressure gauge, manual drain, two quick disconnects to power multiple tools, and twin 8-gallon capacity tanks. Electric model is belt-driven to provide quiet operation (76 dBA) and includes a 6' power cord. The gas-driven model is powered by a premium Honda engine. Available options include regulation panel, cart assembly, hose rack, and weatherproof cover.

- Ergonomically designed with rugged frame support to meet the rigorous demands of field-handling
- Durable cast iron construction; oil lube
- Two quick disconnects to power multiple tools



2340S9GH-AS

Shown with available options.

Installation Kits

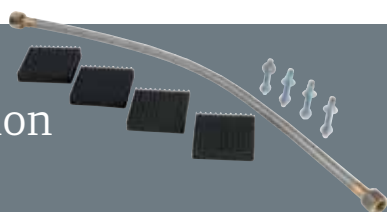

The complete line of Ingersoll Rand Installation Kits can be found on page 94. The complete line of Ingersoll Rand air compressor accessories can be found on pages 94 – 107.

Single-stage Air Compressors

Model	Running Power hp	Voltage DC volts	Tank Capacity gal	Airflow @ 90 psi acfm	Max psi	Air NPT Outlet in	Package Dimensions L x W x H in	Net Weight lb
SINGLE-STAGE — ELECTRIC-DRIVEN								
SS3L3	3	230-1-60	60 vert	11.3	135	3/8"	20" x 23" x 66"	300
SS5L5	5	230-1-60	60 vert	18.1	135	1/2"	20" x 30" x 71"	310

Single-stage

Electric-driven

Our single-stage electric air compressors are ideal for almost anyone — from the do-it-yourselfer to the professional air compressor user. Each compressor features durable cast iron construction, 100 percent continuous-duty cycle for the toughest applications, and extended pump life for years of trouble-free service.

- Industrial-quality design
- Durable cast-iron construction
- 135 psi maximum operating pressure



SS3L3

SS5L5

Two-stage Air Compressors

Model	Running Power hp	Engine	Tank Capacity gal	Airflow @ 175 psi acfm	Max psi	Air NPT Outlet in	Package Dimensions L x W x H in	Net Weight lb
TWO-STAGE TYPE 30 — GAS-DRIVEN								
2475F11.5GKA	11.5	Kawasaki*	30 horiz	25	175	1/2"	45" x 22" x 39"	450
2475F11.5GKA	11.5	Kawasaki	30 horiz	25	175	1/2"	45" x 22" x 39"	425
2475F12.5G	12.5	Kohler*	30 horiz	25	175	1/2"	44" x 22" x 46"	449
2475F12.5G	12.5	Kohler	30 horiz	25	175	1/2"	44" x 22" x 46"	424
2475F13GH	13	Honda*	30 horiz	25	175	1/2"	44" x 22" x 41"	430

*Includes alternator.

Type 30 Series

Gas-driven

Ingersoll Rand Type 30 two-stage compressors meet the needs of fleet or field service applications. Featuring truck-bed mounting, Type 30 units include electronic ignition, idle engine control, a 30-gallon ASME receiver, an OSHA-approved, fully enclosed belt guard, and a weather-resistant powdercoat paint finish.

- Durable cast-iron construction
- 175 psi maximum operating pressure
- Extended pump life
- 100% duty cycle
- Two-year pump warranty with purchase of start-up kit



2475F13GH

Two-stage Air Compressors

Model	Running Power hp	Tank Capacity gal	Airflow @ 175 psi acfm	Max psi	Air NPT Outlet in	Package Dimensions L x W x H in	Net Weight lb
TYPE 30 STANDARD PACKAGE							
2340L5	5	60 vert	14.7	175	1/2"	20" x 33" x 69"	400
2340N5	5	80 vert	14.7	175	1/2"	24" x 33" x 67"	475
2475N5	5	80 vert	16.8	175	1/2"	26" x 38" x 70"	500
2475D5	5	80 horiz	16.8	175	1/2"	67" x 23.5" x 47"	535
2475N7.5	7.5	80 vert	24	175	3/4"	26" x 38" x 70"	500
2545E10V	10	120 horiz	35	175	3/4"	73" x 28" x 51"	835
2545K10V	10	120 vert	35	175	3/4"	44" x 32" x 82"	985
7100E15V	15	120 horiz	50	175	3/4"	72" x 29" x 57"	1,035

*Available voltages: 230/1/60 (5 – 7.5 hp only), 200/1/60 (2475, 5 hp), 200/3/60, 230/3/60, 460/3/60. Please specify voltage required when placing your order.

Type 30 Standard Package

5 to 15 Horsepower

Ingersoll Rand, the world leader in air power, brings industrial-class, two-stage compressors to automotive applications. Featuring a cast-iron pump with splash lubrication for efficient operation and easy serviceability, this new range delivers non-stop performance and reliability for commercial or automotive service applications. Type 30 compressors have been designed to generate maximum air output at 175 psi, with more than 10,000 hours of durability.

- 100% cast iron cylinder head with deep-groove directional cooling fins
- High-efficiency stainless steel valves
- Oversized industrial-grade bearings for extended pump life
- High-efficiency intercooler
- 100% cast iron pump
- High-efficiency inlet air filter with sound attenuation baffles
- Balanced pistons for maximized efficiency and minimized vibration
- Oversized cast-iron balanced belt wheel to allow continuous-duty operation
- Two-year pump warranty with purchase of start-up kit



Purchase an Ingersoll Rand start-up kit and increase the warranty on your pump from one year to two years!



2475N7.5

Lubricants



All-Season Select lubricant is a synthetic, all-temperature blend designed to increase efficiency, reduce wear, and prevent carbon build-up. Use of All-Season Select lubricant extends pump warranty to two years. Ingersoll Rand air compressor accessories can be found on pages 94 – 107.

Two-stage Air Compressors

Model	Running Power hp	Tank Capacity gal	Airflow @ 175 psi acfm	Max psi	Air NPT Outlet in	Package Dimensions L x W x H in	Net Weight lb
TYPE 30 FULL PACKAGE							
2475N5-FP	5	80 vert	16.8	175	3/4"	30" x 37" x 73"	500
2475D5-FP	5	80 horiz	16.8	175	3/4"	67" x 24" x 47"	535
2475N7.5-FP	7.5	80 vert	24	175	3/4"	26" x 38" x 70"	500
2545E10-FP	10	120 horiz	35	175	3/4"	72" x 30" x 56"	835
2545K10-FP	10	120 vert	35	175	3/4"	44" x 32" x 82"	850
7100E15-FP	15	120 horiz	50	175	1"	72" x 30" x 56"	1,035
15TE15-FP	15	120 horiz	53	175	1"	72" x 34" x 61"	1,400
2000E20-FP	20	120 horiz	72	175	1"	75" x 45" x 67"	2,050
2000E25-FP	25	120 horiz	82	175	1"	75" x 45" x 67"	2,050
2545E10VFP**	10	120 horiz	35	175	3/4"	72" x 30" x 56"	835
2545KVFP**	10	120 vert	35	175	3/4"	44" x 32" x 82"	850

*Available voltages: 230/1/60 (5 – 7.5 hp only), 200/1/60 (2475, 5 hp), 200/3/60, 230/3/60, 460/3/60.
Please specify voltage required when placing your order.

** (VFP) models include air-cooled after-cooler, electronic drain valve and AS&S controls.
Does not include low oil level switch.

Type 30 Full Package

In addition to the features on our standard package, the fully packaged models include:

- 5 to 25 hp motors
- Air-cooled aftercooler to help remove additional moisture
- Low oil protection switch to prevent the pump from running dry
- Electronic drain valve that automatically drains water from compressor tank
- Two-year pump warranty with purchase of start-up kit



Purchase an Ingersoll Rand start-up kit and increase the warranty on your pump from one year to two years!

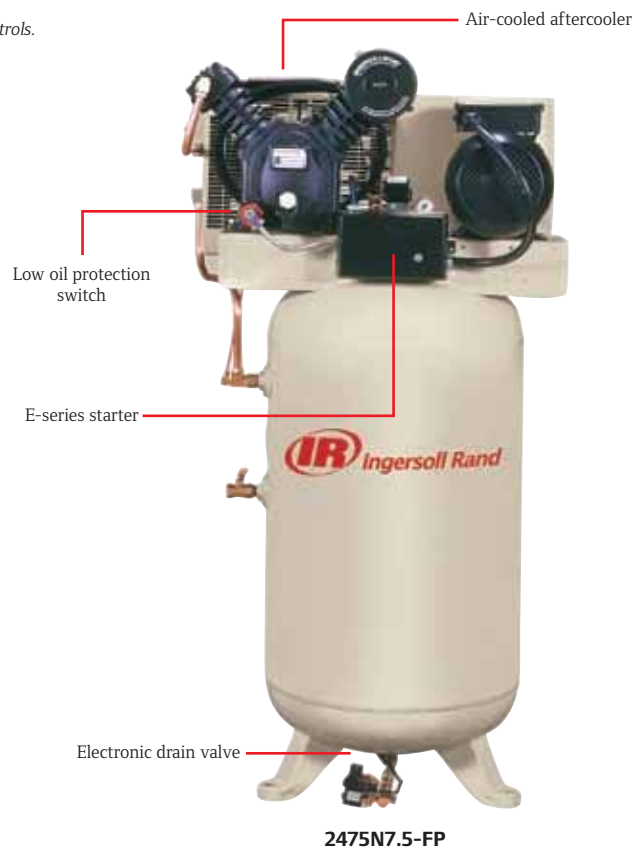

Electric Drain Valves



Ingersoll Rand electric drain valves (EDV) are full-feature automatic electronic drain valves that deliver drier air by removing condensate from compressors, receivers, dryers, aftercoolers, filters, and drip legs. Ingersoll Rand air compressor accessories can be found on pages 94 – 107.

Refrigerated Dryers

Ingersoll Rand refrigerated air dryers protect your tools, machinery, and equipment from harmful moisture while saving energy and reducing system downtime. The unique design improves dryer efficiency and minimizes maintenance by using fewer moving parts. The easy-to-read diagnostic controls provide a constant indication of dryer performance. Units are compact, lightweight, and can be easily installed. Ingersoll Rand refrigerated air dryers are ideal for general industrial applications, and they use environmentally friendly refrigerants.

Protect your downstream equipment by preventing 100% saturated compressed air from rusting tools, and washing away lubricants with a refrigerated dryer. Ingersoll Rand's ISO class 6 refrigerated dryer can handle air flows from 7 to 212 SCFM. The dryer's corrosion resistant heat exchanger is reliable and operationally efficient with low pressure drop and optimized dewpoint performance. An enhanced refrigeration control-system and high-efficiency stainless steel moisture-separation ensure a steady long-term supply of dry air. A variable speed fan further ensures continuous heat removal. Simple controls provide user-friendly operation and a fully adjustable programmable electronic drain valve helps minimize air loss.

Enhance your system's protection by adding superior Ingersoll Rand air filters found on page 91. Continuous long-life operation from your refrigerated dryer is enhanced by installing a dryer pre-filter. Prior to the dryer use the recommended GP particulate filters. HE coalescing oil removal filters virtually eliminate cost due to ruined product finishes, scrapped materials or replacement of pneumatic tools and manufacturing equipment destroyed by contaminated air.



Sizing Table

Site conditions will affect the performance of your refrigerated dryer. Determine your site conditions and multiply the dryer capacity by each factor to determine the air flow that dryer is capable of.

Dryer Inlet Air Temp °F	Correction Factor	Ambient Air Temp °F	Correction Factor	Inlet Pressure psig	Correction Factor
80	1.3	80	1.1	73	0.85
100	1	100	1	102	1
120	0.6	110	0.83	145	1.15
140	0.25	122	0.65	174	1.2
NA	NA	NA	NA	203	1.24

Model	Capacity scfm	Nominal Power Consumption		Connection size			Max Inlet Temp °F	Weight lb	
		kW	Voltage	in					
D12IN	7	0.16	115/1/60	1/2"	12	16	16	140	40
D18IN	11	0.16	115/1/60	1/2"	12	16	16	140	40
D25IN	15	0.16	115/1/60	1/2"	12	16	16	140	40
D42IN	25	0.21	115/1/60	1/2"	16	18	18	140	60
D54IN	32	0.37	115/1/60	1/2"	16	18	18	140	62
D72IN	42	0.37	115/1/60	1/2"	16	18	18	140	62
D108IN	64	0.48	115/1/60	1/2"	16.5	21.5	22.5	140	77
D144IN	85	0.57	115/1/60	1/2"	16.5	21.5	22.5	140	82
D180IN	106	0.71	115/1/60	1"	16.5	21.5	22.5	140	104
D300IN	176	1.25	230/1/60	1-1/2"	20	25.5	38.5	140	192
D360IN	212	1.25	230/1/60	1-1/2"	20	25.5	38.5	140	192

Air Compressor Accessories

Start-up Kits for Electric-driven Air Compressors

Start-up kits include all the parts needed to maintain your compressor for one year, plus the added protection of extended warranty coverage. Kits include:

- All-Season Select® lubricant — a synthetic, all-temperature blend designed to increase efficiency, reduce wear, and prevent carbon build-up
- Replacement filter elements
- Engine oil and filters are also included in kits for gas-driven compressors
- 2-year extended warranty (pump only) based on use of All-Season Select lubricant included in kit



Model	Part Number
ELECTRIC START-UP KITS	
SS3	97338099
SS5	20100251
2000	20102877
2340, 2475	32305880
2545, 7100, 2545N7.5-PS, 7100E10-PS	32305898

Model	Make	Part Number
GAS START-UP KITS		
TS7F12.5G	Kohler	32312936
TS7F13GHG	Honda	32498511
TS7F11.5GKA	Kawasaki	32305872
SS3J5.5GB-WB	Briggs & Stratton	97338610
SS3J5.5GH-WB	Honda	97339501
SS3J5.5GH-AS	Honda	97339501
2475F11GH	Honda	32312936
2475F11.5GKA	Kawasaki	32498511
2475F12.5G	Kohler	32305872



Start-up Kit for Gas-driven Air Compressors

Installation Kits



Kit Number	Description	Part Number	Quantity
1/2" STANDARD INSTALLATION KITS			
38335402*	Vibration pads	32321002	4
	1/2" x 3' braided hose	38335295	1
	1/2" JIC to NPT male adaptor	38335337	2
	1/2" x 4" foundation bolts	38335329	4
	Instruction sheet	22256549	1
3/4" STANDARD INSTALLATION KITS			
38335410**	Vibration pads	32321002	4
	3/4" x 3' braided hose	38335303	1
	3/4" JIC to NPT male adaptor	38335345	2
	1/2" x 4" foundation bolts	38335329	4
	Instruction sheet	22256549	1
1" STANDARD INSTALLATION KITS			
38335394***	1" x 3' braided hose	38335311	1
	1" JIC to NPT male adaptor	38335352	2
	1/2" x 4" foundation bolts	38335329	4
	Instruction sheet	22256549	1

*For compressor models SS3, SS5, TS4/5/51, 2340, and 2475 electric units.

**For compressor models TS7, TS10, TS15, 2475, 2545, and 7100 electric units.

***For 2000 Series electric compressor models. The 1" kits do not have vibration pads due to pads being shipped as standard with the 2000 Series air compressor packages.

Maintenance Kits — TS and SS Series Compressors

Ingersoll Rand Type 30 maintenance kits offer all the parts necessary to perform annual factory-recommended maintenance on your Type 30 compressor. Conveniently packaged, the kits can save you 20 to 30 percent more than purchasing parts individually.

Features

- One fill of All-Season Select lubricant
- One replacement air filter element
- All replacement gaskets and O-rings required to clean and inspect valves
- Easy-off maintenance reminder sticker to track when next maintenance is due



Model	Valve / Gasket Kit	Ring / Gasket Kit	Bearing Kit	Air Filter	Overhaul Kit	Gasket Kit
MAINTENANCE KITS						
SS3 electric units	97338107	97338115	N/A	70243712	N/A	N/A
SS5 electric units	20100277	20100285	N/A	32170979	N/A	N/A
2000 electric units	20103081	20103099	20103107	32170979	22222053	N/A

Type 30 Maintenance Kits

Model	Maintenance Kit
COMPRESSOR MAINTENANCE KITS	
2340	38485314
2475	38485330
2545	38485298
7100	38485322

Lubricants

All-Season Select Lubricant

All-Season Select lubricant is a synthetic, all-temperature blend designed to increase efficiency, reduce wear, and prevent carbon build-up. It performs four times longer than petroleum-based lubricants. Recommended 2,000 hours of service between lubricant change-out under normal operating conditions.



Coolant / Lubricant	Base Stock	Viscosity Index	Hours	ISO Viscosity Grade	SAE Grade
LUBRICANT					
All-Season Select	Diester	128	2,000	68 / 150	20W40

All-Season Select	Quantity	Part Number
LUBRICANT		
Box of quarts	(12) 1 qt	34836739
Box of 1/2 liters	(6) 1/2 liter	97338149

Air Compressor Accessories

Electric Drain Valves (EDV)

Ingersoll Rand electric drain valves (EDV) are full-feature automatic electronic drain valves that deliver drier air by removing condensate from compressors, receivers, dryers, aftercoolers, filters, and drip legs.

Features / Benefits

- Extend life of pneumatic equipment and tools
- Eliminate manual draining
- Prevent rusting and clogging
- 2-year warranty
- Maximum 250 psi



Voltage 110 / 120 V	Voltage 230 / 240 V	Inlet Pipe Connection	Outlet Pipe Connection	Orifice
ELECTRONIC DRAIN VALVES (EDV)				
37995925	37995933	0.5 NPT	0.25 NPT	3/32"
54410931	37995909	0.5 NPT	0.25 NPT	7/16"
37995891	37995917	0.5 NPT	0.5 NPT	7/16"
38000865	38000873	0.5 BSP	0.25 BSP	7/16"
38000808	38000881	0.5 BSP	0.5 BSP	7/16"
54579248*	97339402	JIC-14	0.25 NPT	3/32"

*JIC connection for field retrofits on T30 compressors.

Part Number	Description
ELECTRONIC DRAIN VALVES (EDV)	
54381090	1/2" x 1/4" male NPT valve connection
37996337	1/2" x 1/4" male NPT valve connection
38000154	Stainless steel filter screen
54381090	JIC — 14" x 1/4" NPT

PacE Controller

PacE air controllers provide total air system control through a single device, giving you the ability to see both upstream and downstream pressures from one convenient location.

Benefits

- Energy savings of 7 percent for every 14 psi reduction in system pressure
 - Reduces pressure of air leaking from a system; all systems can potentially have leaks, but losing air at 80 psi is better than losing it at 125 psi
- Single-point control for your whole system
 - Eliminates the need to regulate airflow at every point in the system
- Prolonged compressor and equipment life
 - Protects all downstream equipment by preventing high pressure from feeding into the system and reducing the life expectancy of the equipment
- Reduced maintenance costs
 - It is possible in some installations to turn off the compressor, achieving power cost savings
- Simple installation and operation



Connection Size	Max Flow Rate cfm	Max Inlet Pressure psig	Control Range psig	Operating Temperature Range	Dimensions L x H x W in
PACE CONTROLLER					
1" NPT female	250	232	145 - 7	176° - -4° F	9.5" x 6" x 6.5"

Model	Description
38334314	PacE unit
38036281	Repair kit

CMS-6 Condensate Controller

The CMS-6 condensate controller is the industry’s most reliable and environmentally safe solution for condensate management in light industrial air systems.

How the CMS-6 Controller Works

The system’s air and condensate discharge enters the CMS-6 through six inlet check valves located on the bottom left-hand side of the unit. Each of these inlets can be connected to any system drain point using the included installation hardware and tubing. When the system’s drain valve actuates, the entire condensate supply is relieved through the single discharge line on the bottom right-hand side of the unit. To optimize energy savings and condensate control, the CMS-6’s integrated timer is set by the operator to enable condensate control based on the compressor’s operating schedule.

Model	Description
CMS-6 CONDENSATE CONTROLLER	
38432621	125’ of transparent polyurethane 1/4” tubing
38432613	1/8” NPT check valve

CMS-6 Major Components

1. Installation hardware
2. (6) 1/4” x 1/8” NPT inlet check valves
3. Electric drain valve (w/ strainer and drain line)
4. Integrated 24/7 system timer
5. (1) 3/8” system condensate outlet and (1) 1/4” service drain line
6. (1) 115 V electrical connector

➔ Represents condensate path

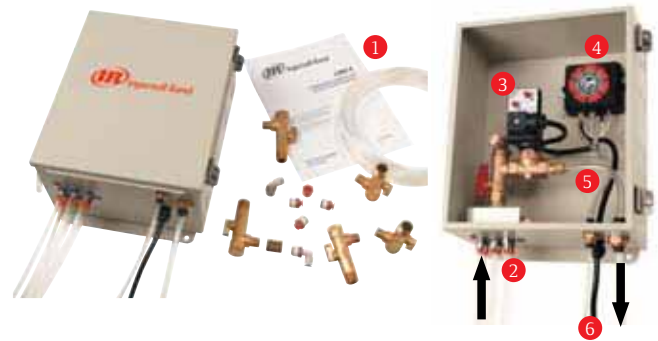

Air Compressor Accessories

PolySep Condensate Systems

PolySep condensate systems address the inability of traditional gravity separators to handle emulsions, such as polyglycol lubricant. The unique design of the PolySep system utilizes a proprietary adsorption module to break the chemical bond and entrain the emulsified lubricant within the adsorption module. The solids are collected in the adsorption module and the cleaned condensate is safely disposed of into the sanitary sewer.

Kits Include

- (2) 2-way 1/4" manifolds
- (2) reducing bushings
- (8) 1/4" plugs



PS-125



PS-030 and PS-060



Advantages of PolySep Condensate Separators

- Work with biodegradable (polyglycol) fluids and ultra coolant
- Also work with mineral oil, PAO's, polysol esters, and diesters
- No electricity — rated for 250 psi
- Fully automatic
- Multiple capacities allow for systems that use multiple equipment with different lubricant to be sent to one location for separation
- Easy to maintain — adsorption modules are sized to operate 8,000 hours or for one year under standard operating conditions; adsorption modules are self-contained and easy to change and dispose
- 1-year warranty

Model	Part Number	Max Capacity cfm	Max hp	Adsorption Module Volume	Condensate Inlet in	Oil Outlet in	Water Outlet in	Dimensions L x W x H in	Weight lb
POLYSEP CONDENSATE SYSTEMS									
PS-030	38041596	30	10	1	1/2"	1/2"	1/2"	N/A	15
PS-060	42528455	60	15	1	1/2"	N/A	3/4"	11.5" x 11.5" x 27.5"	25
PS-125	38339040	125	30	5	1/2"	N/A	3/4"	28.5" x 19.5" x 30.8"	N/A

Model	Part Number
POLYSEP REPLACEMENT ADSORPTION MODULES	
PS-030	38041604
PS-060	42528505
PS-125	38339057

Part Number	Description
POLYSEP PUMP REBUILD KITS	
38336897	Diaphragm kit
38041752	Check valve kit
38041760	Spool kit

In-line Air Filters

Ingersoll Rand coalescing filters save energy and protect your tools, machinery, and equipment from harmful contaminants by effectively removing solid particulates, liquid water, oil, and aerosols from compressed air.

Unique in design, these in-line filters allow simple and fast maintenance with a patented zero-clearance element removal. Lighted indication ensures continued filtration performance. When it is time to replace the filter element, the lighted Element Change Indicator will illuminate with a rapid flash allowing your process to be continuously protected while minimizing the pressure drop in the compressed air system – saving you money.

Our general purpose filters remove particulates down to 1.0 micron, which meets general industry requirements for coarse filtration. Our high-efficiency filters remove contaminants down to 0.01 micron, which meets difficult compressed air filtration requirements.



Replacement Element	Part Number
GENERAL PURPOSE REPLACEMENT FILTER ELEMENTS	
F35IG	85565505
F71IG	85565547
F108IG	85565588
F144IG	85565620
F178IG	85565661
F212IG	85565703
F395IG	85565745
F424IG	85565786
HIGH-EFFICIENCY REPLACEMENT FILTER ELEMENTS	
F35IH	85565513
F71IH	85565554
F108IH	85565596
F144IH	85565638
F178IH	85565679
F212IH	85565711
F395IH	85565752
F424IH	85565794

"G" General Purpose Filter Model*	"H" High-Efficiency Filter Model**	Flow	Max Pressure psi	Inlet/Outlet NPT	Filter Rating Microns		Dimensions	
					"G" Models	"H" Models	H	W
F35IG	F35IH	21	250	1/2"	1	0.01	10.0"	3.0"
F71IG	F71IH	42	250	3/4"	1	0.01	12.25"	3.84"
F108IG	F108IH	64	250	3/4"	1	0.01	12.25"	3.84"
F144IG	F144IH	85	250	1"	1	0.01	13.4"	5.08"
F178IG	F178IH	105	250	1"	1	0.01	13.4"	5.08"
F212IG	F212IH	125	250	1"	1	0.01	13.4"	5.08"
F395IG	F395IH	233	250	1-1/2"	1	0.01	16.9"	5.08"
F424IG	F424IH	250	250	1-1/2"	1	0.01	16.9"	5.08"

*G = General Purpose, 1 micron rating

** H = High Efficiency, 0.01 micron rating



Replacement Element	Part Number
GENERAL PURPOSE REPLACEMENT FILTER ELEMENTS, FILTER 2000	
GP19E	88342977
GP40E	88342985
GP64E	88342993
GP123E	88343124
GP216E	88343132
HIGH-EFFICIENCY REPLACEMENT FILTER ELEMENTS, FILTER 2000	
HE19E	88343009
HE40E	88343017
HE64E	88343025
HE123E	88343157
HE216E	88343165

Air Compressor Accessories

Aluminum Piping and Tubing

SimplAir EL

SimplAir EL is designed to provide an efficient, low-cost method of installing compressed air piping systems. SimplAir EL is a unique, round aluminum extrusion, manufactured in line with SimplAir's advanced piping concept.

Benefits

- Good-quality air
- More efficient air delivery
- Reduced pressure loss
- Higher flow rates
- Easy and fast installation

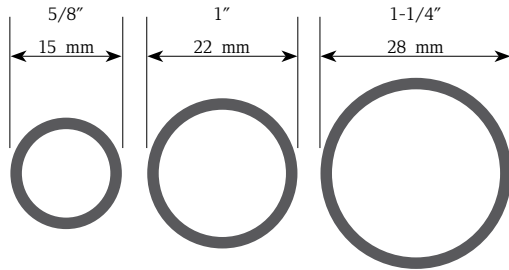

Part Number	Tube OD in (mm)	Tube Length ft (m)	Package Quantity ft (m)	cfm @ 103 psig	cfm @ 118 psig	cfm @ 147 psig
ALUMINUM PIPING						
22285282	5/8" (15)	10' (3)	10'	36	38	42
38332540	1" (22)	10' (3)	10'	75	86	111
38332656	1-1/4" (28)	10' (3)	10'	126	148	175

SimplAir EL Fittings

- Provides ideal connection from the compressed air receiver throughout the entire distribution system, right to the point-of-use
- A compressed air piping system can be installed quickly and easily, considerably reducing production downtime
- No need to prepare threaded pipe or apply solvent — all connections can be made with a simple push-in action
- Complex systems can be assembled much more rapidly than with traditional methods
- Since they also are easy to disconnect, systems can be altered or extended with little effort

Adaptability — Standard SimplAir EL products can be coupled to form integral new fittings.

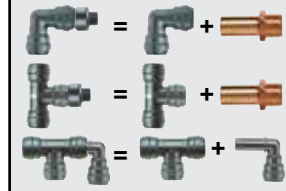

Equal Elbow



Straight Connector



Equal Tee



Reducing Tee



Stem Elbow



Reducer

Part Number	Tube OD in (mm)	Branch Line in (mm)	Stem OD in (mm)
EQUAL ELBOWS			
38039756	5/8" (15)	N/A	N/A
38332565	1" (22)	N/A	N/A
38332672	1-1/4" (28)	N/A	N/A
STRAIGHT CONNECTORS			
38039772	5/8" (15)	N/A	N/A
38332557	1" (22)	N/A	N/A
38332664	1-1/4" (28)	N/A	N/A
EQUAL TEES			
38039764	5/8" (15)	N/A	N/A
38332573	1" (22)	N/A	N/A
38332680	1-1/4" (28)	N/A	N/A
REDUCING TEES			
38039814	1" (22)	5/8" (15)	N/A
STEM ELBOWS			
38039780	5/8" (15)	N/A	N/A
38332623	1" (22)	N/A	N/A
REDUCERS			
38039798	5/8" (15)	N/A	1" (22)
38039806	5/8" (15)	N/A	1-1/4" (28)
38332581	1" (22)	N/A	1-1/4" (28)

SimplAir EL Fittings

Part Number	Pipe OD in (mm)	Thread BSP in	Thread NPT in
BRASS WING BACK			
38039855	5/8" (15)	1/2"	1/2"

Part Number	Thread BSP in	Thread NPT in
FEMALE THREADED MANIFOLDS		
54742721	1"	N/A
38004339	N/A	1"

Part Number	Stem OD in (mm)	Thread BSP in	Thread NPT in
MALE BRASS STEM ADAPTERS			
38039822	5/8" (15)	1/2"	1/2"
38332599	1" (22)	3/4"	N/A
38332607	1" (22)	1"	N/A
38332698	1-1/4" (28)	1"	N/A
38332961	1" (22)	N/A	3/4"
38332615	1" (22)	N/A	1"
38332706	1-1/4" (28)	N/A	1"



Brass Wing Back



Female Threaded Manifold



Male Brass Stem Adapter

Manifolds are supplied with the following plugged outlets:

- 2" x 1/4"
- 2" x 3/8"
- 2" x 1/2"
- 1" x 1"

Water Trap Tee

Part Number	Tube OD in (mm)	Size in (mm)
WATER TRAP TEE		
38332631	1" (22)	N/A
WATER TRAP TEE CONVERTER		
38332714	N/A	1-1/4" (28)

Water Trap Tee

The unique water trap tee helps reduce continual moisture in a piping system and is an easy alternative to installing swan and goose necks.

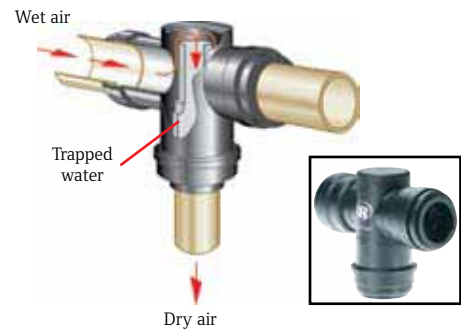

Water Trap Tee Converter

The water trap tee converter is a simple and convenient way to convert a standard 1-1/4" (28 mm) tee into a water trap tee. When fitted, it will stop condensed water within the piping system from entering the vertical take-off spurs.

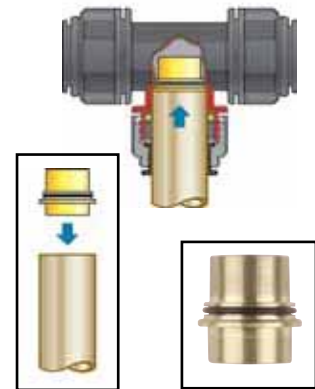

Air Compressor Accessories

Part Number	Tube OD in (mm)	Color
PLUGS		
38039830	5/8" (15)	Black
38332649	1" (22)	Black
38332722	1-1/4" (28)	Black



Plug

Part Number	Tube Sizes in (mm)
PIPE CUTTER	
88162466	1" - 1-1/4" (22 - 28)



Pipe Cutter

Part Number	Tube OD in (mm)	Color
PIPE CLIPS		
38039848	5/8" (15)	Black
38332730	1" (22)	Black
38332755	1-1/4" (28)	Black
PIPE SPACER		
38332748	1" - 1-1/4" (22 - 28)	Black

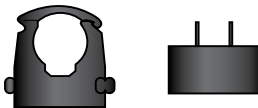

Pipe Clip and Spacer

Part Number	Tube Size in (mm)
BALL VALVES WITH COMPRESSOR ENDS	
88315635	5/8" (15)
88306139	1" (22)
88306402	1-1/4" (28)

SPARE NUTS FOR BALL VALVES	
88315650	5/8" (15)
88306410	1" (22)
88306436	1-1/4" (28)

SPARE FERRULES FOR BALL VALVES	
88315643	5/8" (15)
88306428	1" (22)
88306444	1-1/4" (28)



Ball Valve with Compressor End

Part Number	Package Quantity	Wire Length
LOOP-FAST HANGING SYSTEMS		
38330643	10	5'
38330650	10	10'
38330668	10	15'
38330676	10	30'



Loop-fast Hanging System

SimplAir EL Installation

The Old Way

A time-consuming and difficult process.

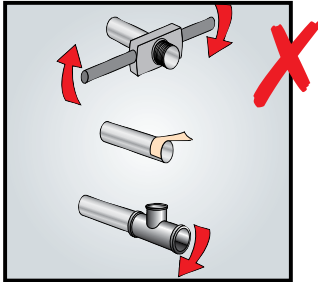

Solvent Weld

Long installation time; system needs to be shut down for drying.

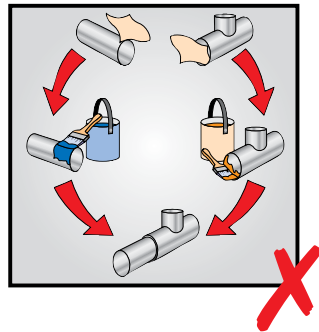

The SimplAir EL Way

One simple movement provides a secure connection and the system is immediately ready for use.

- Designed for piping system applications
- Safe, secure, and leakproof
- Easy to install
- Easy to disconnect and reconfigure
- Many millions of fittings in use
- Working pressures from 0 to 10 bar
- Tested to ANSI B31.1



Easy Installation

- To make a connection, simply push the tube in by hand
- The unique, patented SimplAir EL collet locking system holds the tube firmly in place without deforming it or restricting flow

Pipe Cutting

- Cut the pipe cleanly to ensure it is free of score marks
- For SimplAir EL aluminum pipe, use a SimplAir EL pipe cutter
- Do not use a hacksaw
- To avoid damage to the O-ring, make sure burrs and sharp edges are removed

Use a SimplAir EL Pipe Cutter

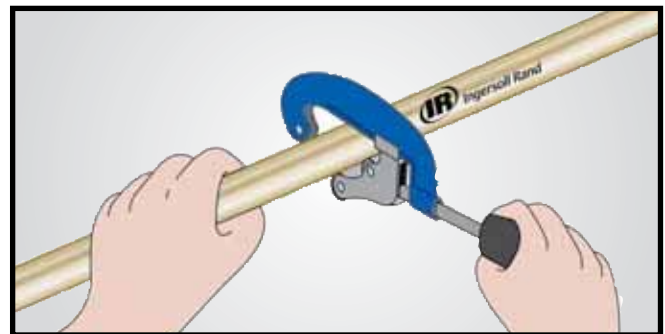

SimplAir EL Installation continued

5/8" and 1" Fittings

Make a Connection

1. Fittings and pipe should be clean and undamaged before use.



2. With the fitting clean and undamaged, and the pipe cut squarely as described, you are now ready to make the connection.

Push Up to Pipe Stop



3. Push the pipe into the fitting to the pipe stop. The collet (gripper) has stainless steel teeth that will hold the pipe firmly in position while the O-ring provides a permanent leakproof seal.

Pull to Check if Secure



4. Pull on the pipe to check that it is secure. It is critical to test the system prior to leaving the site or before use.

Disconnect



1. Ensure the system is depressurized.
2. Push the collet in and remove the pipe.
3. Push in collet squarely against the face of the fitting.
4. With the collet held in this position, the pipe can be removed, and the fitting can be reused.

Installation

Installing a Piping System

1. Attach only the horizontal pipe clips.
2. Only after a small amount of pressure has been applied to the system, attach the clips to the vertical pipes. This will ensure the vertical pipes have positioned themselves correctly before they are clipped.
3. On long pipe runs, install an expansion bend every 75' (25 m).

Install clips first.

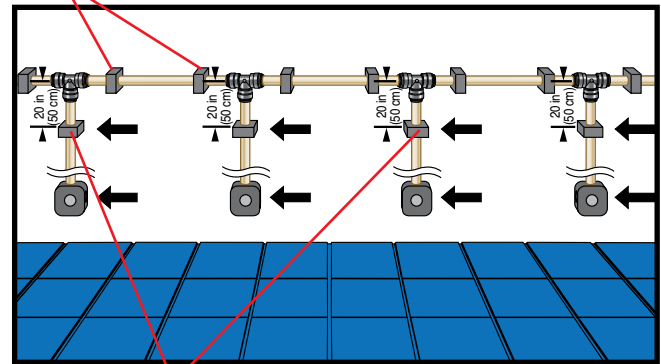

Install vertical clips after the system is pressurized.

Installing a Piping System Around a Column

1. Maintain a distance of approximately 4" (10 cm) between the wall and the pipe.
2. Always maintain a distance of 20" (50 cm) between the fittings and the pipe clip.

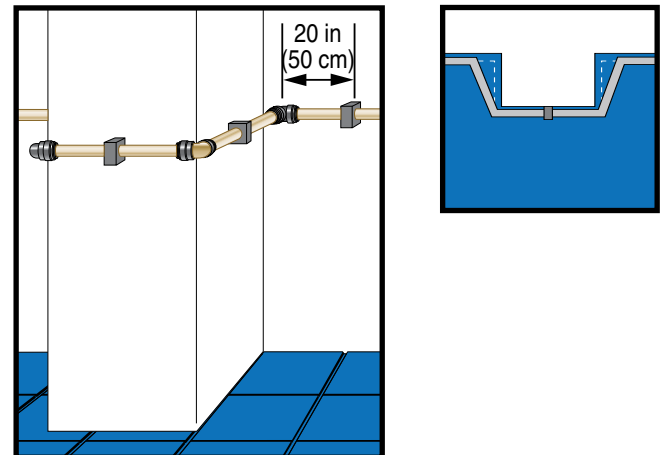

Filters

Part Number	NPT in	Flow Rate cfm	Bowl Size oz	Bowl Type	Weight lb
FILTERS					
F111-420	1/8" mini	28	1.1	Composite nylon	1.48
F121-420	1/4" mini	38	1.1	Composite nylon	1.46
F221-410	1/4"	54	6	Metal	1.48
F231-410	3/8"	100	6	Metal	1.46
F241-410	1/2"	122	6	Metal	1.43
F28-60-SK00-28	3/4"	168	2.87	Poly	1.9
F38-60-SK00-28	1"	325	8	Metal with automatic drain	2.2

Features

- Pipe sizes from 1/8" to 1" NPT
- Flows to 325 cfm
- Maximum inlet pressures to 250 psig



Regulators

Part Number	NPT in	Flow Rate cfm	Adjusted Pressure Range psig	Weight lb
REGULATORS				
R111-600	1/8" mini	13	5 - 125	1.38
R121-600	1/4" mini	13	5 - 125	1.34
R221-600	1/4"	100	5 - 125	1.38
R231-600	3/8"	130	5 - 125	1.34
R241-600	1/2"	150	5 - 125	1.3
R28-06-F0G0-28	3/4"	125	5 - 125	2.35
R38-06-F0G0-28	1"	491	10 - 125	2.5

Features

- Pipe sizes from 1/8" to 1" NPT
- Flows to 491 cfm
- Maximum inlet pressures to 300 psig



Lubricators

Part Number	NPT in	Flow Rate cfm	Bowl Size oz	Bowl Type	Weight lb
LUBRICATORS					
L111-120	1/8" mini	41	1.1	Composite nylon	1.5
L121-120	1/4" mini	41	1.1	Composite nylon	1.5
L221-110	1/4"	75	6	Metal	1.5
L231-110	3/8"	100	6	Metal	1.46
L241-110	1/2"	110	6	Metal	1.36
L28-06-LK00-28	3/4"	200	6.11	Poly	1.9
L38-06-LL00-28	1"	440	19	Metal with automatic drain	2.2

Features

- Pipe sizes from 1/8" to 1" NPT
- Flows to 440 cfm
- Maximum inlet pressures to 250 psig



Inline Filter

Model	Port Size NPT in	Flow Rate cfm	Filter Element micron	Weight lb
INLINE FILTER				
F01-02-000	1/4"	22	5	0.1

Features

- Designed to provide protection for portable pneumatic hand tools
- Weighs only 2 ounces
- Throw-away filter element rated at 5 microns
- Either port may be used as the inlet port
- Flow is 22 cfm
- Maximum inlet pressures to 150 psig



Air Tool Oil

Using a lubricator with genuine Ingersoll Rand Air Tool Oil will keep your tools running at peak performance. See page 124 for air tool oil offerings.

Accessories

Part Number	Port Size (F) NPT in	Flow Rate cfm	Bowl Size oz	Weight lb
IN-LINE LUBRICATOR				
L01-02-000	1/4"	36	0.25	0.2
L01-02-000	3/8"	38.1	0.25	0.2



Features

- Assure proper lubrication for small pneumatic hand tools
- Oil capacity is 0.25 oz
- Requires cyclical or intermittent airflow for proper operation
- Cannot be filled under pressure

Piggyback Combination Over / Under Filters

Part Number	NPT in	Flow Rate cfm	Bowl Size oz	Filter Element micron	Bowl Type	Adjusted Pressure Range psig	Weight lb
PIGGYBACK COMBINATION FILTERS							
P114-620	1/8" mini	13	1.1	20	Composite nylon	5 – 125	2.05
P122-620	1/4" mini	13	1.1	20	Composite nylon	5 – 125	2.03
P124-620	1/4" mini	13	1.1	40	Composite nylon	5 – 125	2.03
P221-610	1/4"	93	6	40	Metal	5 – 125	2.05
P224-610	1/4"	93	6	40	Metal	5 – 125	2.05
P234-610	3/8"	135	6	40	Metal	5 – 125	2.03
P244-610	1/2"	140	6	40	Metal	5 – 125	2



Combination Filters

Part Number	NPT in	Flow Rate cfm	Bowl Size oz	Filter Element micron	Bowl Type	Adjusted Pressure Range psig	Weight lb
COMBINATION FILTERS							
C121-820	1/4" mini	13	1.1	20	Composite nylon	5 – 125	1.2
C122-620	1/4" mini	13	1.1	20	Composite nylon	5 – 125	1
C221-610	1/4"	75	6	40	Metal with sight glass	5 – 125	5.48
C221-810	1/4"	54	6	40	Metal with sight glass	5 – 125	6.98
C231-610	3/8"	100	6	40	Metal with sight glass	5 – 125	5.43
C231-810	3/8"	100	6	40	Metal with sight glass	5 – 125	6.35
C241-610	1/2"	110	6	40	Metal with sight glass	5 – 125	6.38
C241-810	1/2"	110	6	40	Metal with sight glass	5 – 125	6.69



Regulators / lubricators with gauge.

Liquidator™ Filters / Dryers

Part Number	NPT in	Description	Flow Rate cfm
FILTERS			
TS-4000	1/2"	Liquidator tool saver	60
EAD-6000	1/2"	Liquidator prep station air dryer	60
PDS-2000	1/2"	Liquidator paint booth dessicant dryer	25

Part Number	Stage	Used In	Quantity
REPLACEMENT ELEMENTS			
8844-060	One	EAD-6000	1
8844-060C	Two	EAD-6000	1
8844-460	One	PDS-2000	1
8844-DES	Two	PDS-2000	1
8844-DES-6	Two	PDS-2000	6
8844-060	One and two	TS-4000	1

Features

- Centrifugal spinning
- Stainless steel media
- Friction drying and filtered air to one micron
- Inverse flow
- Automatic drain



Rotary Start Up Kits and Accessories

Part Number	Description
ROTARY START-UP KITS	
38339297	UP6 5-15c
38028577	UP6 20-40
ACCESSORIES	
38342028	Panel Filter: UP6 5-15c (4-Pack)
38338463	Electrical Installation Kit: 1-phase UP6 5-15c
22469183	Maintenance Kit: UP6 5-15c
38335410	Installation Kit: UP6 5-15c

Lubrication Equipment



Ingersoll Rand lubrication equipment reflects the same high standards of performance as Ingersoll Rand tools and air compressors, with a full range of products that will keep all types of fluids moving efficiently. They are backed by more than 70 years of experience in pump and air system technology, and include models specifically designed for popular applications.



LM and LP Series Piston Pumps



Built Tough to Fit the Way You Work

Ingersoll Rand LM Series piston pumps deliver unmatched industrial-strength performance for pumping fluids with sizes to fit small (16 gal / 35 lb) or large (275 gal / 400 lb) containers. Working flow rates range from 2 to 6 gallons per minute. Pumps are offered from 3:1 to 50:1 ratios, in order to meet the requirements of any application. Our LM Series is ideal for pumping grease, motor oil, gear oil, or transmission fluid. The simple, durable design allows for piston pump service by any owner or qualified technician. Also look for our convenient grease and oil pump packages.

Features and Benefits

- Pump's patented design improves flow, reduces pulsation, and extends service life
- Offers simple self-service maintenance due to advanced design with 50% fewer parts
- Reduces service time, due to inline service design with no special tools required
- Features stall-free, ice-free air motor with tough, durable housing

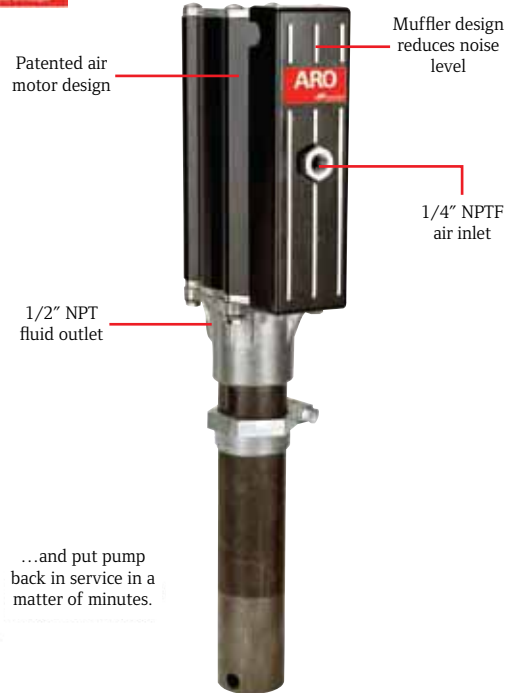

Inline Service for 3:1 Piston Pumps

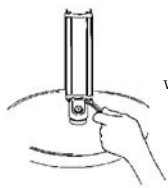

One standard wrench to loosen four nuts...



...allows you to replace all dynamic service kit items — no additional wrenches required for 3:1...

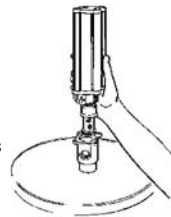

...and put pump back in service in a matter of minutes.

LM Series Piston Pumps

Model	Working Flow gpm (L/min)	Free Flow gpm (L/min)	Fluid Inlet / Outlet NPTF in (mm)	Container gal	Air Inlet in (mm)
3:1 PISTON PUMPS					
LM2203A-11-C	6 (23)	9 (34)	3/4" / 1/2" (19 / 13)	Stub	1/4" (6)
LM2203A-31-C	6 (23)	9 (34)	3/4" / 1/2" (19 / 13)	16	1/4" (6)
LM2203A-41-C	6 (23)	9 (34)	3/4" / 1/2" (19 / 13)	55	1/4" (6)
LM2203A-51-C	6 (23)	9 (34)	3/4" / 1/2" (19 / 13)	275	1/4" (6)
5:1 PISTON PUMPS					
LM2305A-11-B	6 (23)	9 (34)	1-1/2" / 1/2" (38 / 13)	Stub	1/4" (6)
LM2305A-31-B	6 (23)	9 (34)	1-1/2" / 1/2" (38 / 13)	16	1/4" (6)
LM2305A-41-B	6 (23)	9 (34)	1-1/2" / 1/2" (38 / 13)	55	1/4" (6)
LM2305A-51-B	6 (23)	9 (34)	1-1/2" / 1/2" (38 / 13)	275	1/4" (6)
50:1 PISTON PUMPS					
	ppm (kg/min)	ppm (kg/min)	Outlet NPTF in	Weight lb	
LM2250E-21-B	2 (1)	9 (4)	3/8"	35	1/4" (6)
LM2250E-31-B	2 (1)	9 (4)	3/8"	120	1/4" (6)
LM2250E-41-B	2 (1)	9 (4)	3/8"	400	1/4" (6)
LM2250E-61-B	2 (1)	9 (4)	3/8"	60	1/4" (6)
LM2350E-21-B	4 (2)	7.5 (3)	3/8"	35	1/4" (6)
LM2350E-31-B	4 (2)	7.5 (3)	3/8"	120	1/4" (6)
LM2350E-41-B	4 (2)	7.5 (3)	3/8"	400	1/4" (6)
LM2350E-61-B	4 (2)	7.5 (3)	3/8"	60	1/4" (6)

Lubrication Equipment

LP Series Piston Pumps

Model	Description	Pump	Meter	Control Handle	Dolly	Drum Cover	Hose	Valve			
PORTABLE OIL PUMP PACKAGES											
LP2100-1-B	3:1 ratio, 16 gal	LM2203A-31-C	635190-1	635190-1	640058-2	94421	623501-6	67085			
LP3100-1-B	5:1 ratio, 16 gal	LM2305A-31-C	635190-1	635190-1	640058-2	94421	623501-6	N/A			
Model	Description	Pump Meter	Handle	Control Dolly	Cover	Drum Hose	Plate	Follower Handle	Adaptor	Z-Swivel	
GREASE PUMP PACKAGES											
LP2001-1-B	2" diameter air motor, 35 lb	LM2250E-21-B	N/A	N/A	N/A	94420	N/A	640095-2-B	94434	N/A	N/A
LP2002-1-B	2" diameter air motor, 35 lb	LM2250E-21-B	N/A	636111	N/A	94420	624201-10	640095-2-B	94434	76493	636077
LP2003-1-B	2" diameter air motor, 120 lb	LM2250E-31-B	N/A	N/A	N/A	94421	N/A	640165	N/A	N/A	N/A
LP2004-1-B	2" diameter air motor, 120 lb	LM2250E-31-B	N/A	636111	N/A	94421	624201-10	640165	N/A	76493	636077
LP2006-1-B	2" diameter air motor, 120 lb	LM2250E-31-B	N/A	636111	640058-2	94421	624201-10	640165	N/A	76493	636077
LP3001-1	3" diameter air motor, 35 lb	LM2350E-21-B	N/A	636103	N/A	94420	624201-10	640095-2-B	94434	76493	636077
LP3002-1	3" diameter air motor, 120 lb	LM2350E-31-B	622201-3	N/A	N/A	94421	624401-4	640165	N/A	N/A	N/A
LP3003-1	3" diameter air motor, 120 lb	LM2350E-31-B	N/A	636103	N/A	94421	624401-4	640165	N/A	76493	636077
LP3004-1	3" diameter air motor, 120 lb	LM2350E-31-B	N/A	636111	N/A	94421	624401-4	640165	N/A	76493	636077
LP3005-1	3" diameter air motor, 400 lb	LM2350E-41-B	622201-3	N/A	N/A	94421	624401-4	640165	N/A	N/A	N/A
LP3007-1	3" diameter air motor, 60 lb	LM2350E-61-B	N/A	636111	N/A	71740-1	624401-4	N/A	N/A	N/A	N/A



LP3001-1



LP3003-1



LP3100-1-B

Piston Pumps

Model	Working Flow gpm (L)	Free Flow gpm (L)	Air Inlet NPT (F) in	Fluid Outlet NPT (F) in	Container gal (L)	Accessories
SERIES 200 PISTON PUMPS — 1:1 RATIO 2" DIAMETER AIR MOTOR						
612041-1	9 (34)	18 (68)	1/4"	3/4"	55 (208.2)	Bung adapter
612041-3*	9 (34)	18 (68)	1/4"	3/4"	55 (208.2)	Bung adapter
612042-1	9 (34)	18 (68)	1/4"	3/4"	275 (1041)	Bung adapter
SERIES 425 PISTON PUMPS — 9:1 RATIO 4.25" DIAMETER AIR MOTOR						
662420-B*	3.9 (14.8)	21 (79.4)	1/4"	3/4"	Stub	N/A
662409*	3.9 (14.8)	21 (79.4)	1/4"	3/4"	16 (60.57)	N/A
662410-B	3.9 (14.8)	21 (79.4)	1/4"	3/4"	55 (208.2)	N/A

*Not pictured.

PISTON PUMPS

Motor Oil, Gear Oil, and Transmission Fluid

612041-1

This 1:1 ratio pump is ideal for pumping motor oil, gear oil, and transmission fluid. This model fits a standard 55-gallon drum (including bung adapter).



612042-1

Our 1:1 ratio piston pumps are ideal for moving oils and fluids at high volumes. This model is designed for 275-gallon onboard tanks.



662410-B

425 Series pumps are designed with a 9:1 pump ratio, 1/4" air motor, and are ideal for pumping heavy oils over long distances.



Diaphragm Pumps

Our diaphragm pumps are ideal for pumping oil or other light fluids such as anti-freeze, water, windshield fluid, fuel, solvents, transmission fluid, and waste oil. ARO diaphragm pumps range in size from 3/8" to 2" to meet the requirements of any application.

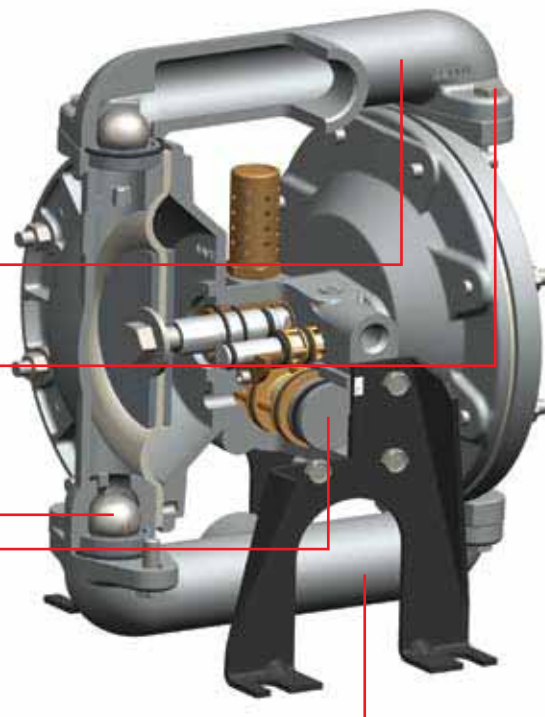

Features and Benefits

- Ideal for abrasion and solids handling
- From top to bottom, ARO's flap valve pump is your best high solids-handling choice
- Bolted construction for reliability and ease of assembly
 - Bolted is safer
 - Bolted is reliable
 - Bolted is easier to assemble
 - Bolted is less expensive
- Positive priming provides instant start-ups
- ARO's patented "unbalanced" air valve
 - Eliminates shifting / freezing problems
 - Uses significantly less power than competition
 - Does not require lubrication
 - Forgiving in dirty air
- Uninstallable air motor design: SimulShift™
- Broad material selection
- Commitment — Ingersoll Rand diaphragm pumps come with a 5-year warranty.

Diaphragm Pumps

Model	Body Materials (Wetted)	Diaphragm / Ball Material	Air Inlet NPT (F) in	Fluid Inlet / Outlet Material in	Max Flow gpm	Compatible Fluids	Replaces Model
3/8" PORTS							
PD03P-ARS-PTT	Polypropylene	Teflon and anti-freeze	1/4"	3/8"	10.6	Windshield fluid, motor / gear oil, transmission fluid	New
PD03P-ARS-PCC	Polypropylene	Hytrel	1/4"	3/8"	10.6	windshield fluid, motor / gear oil, transmission fluid, anti-freeze	New
PD03P-AES-DTT	Acetal (groundable)	Teflon	1/4"	3/8"	10.6	Solvents	New
PD03P-AES-DCC	Acetal (groundable)	Hytrel	1/4"	3/8"	10.6	Windshield fluid, motor / gear oil, transmission fluid, anti-freeze	New
1/2" PORTS							
PD05P-ARS-PTT-B	Polypropylene	Teflon	1/4"	1/2"	14.4	Windshield fluid, motor / gear oil, transmission fluid, anti-freeze	66605J-344
PD05P-ARS-PCC-B	Polypropylene	Hytrel	1/4"	1/2"	14.4	Windshield fluid, motor / gear oil, transmission fluid, anti-freeze	66605J-322
PD05P-ARS-PAA-B	Polypropylene	Santoprene	1/4"	1/2"	14.4	Windshield fluid / anti-freeze	66605J-388
PD05P-AES-DTT-B	Acetal	Teflon	1/4"	1/2"	14.4		666056-6A4
PD05P-AES-DCC-B	Acetal	Hytrel	1/4"	1/2"	14.4	Windshield fluid, motor / gear oil, transmission fluid, anti-freeze	66605H-622
66605J-344*	Polypropylene	Teflon	1/4"	1/2"	13	Windshield fluid, motor / gear oil, transmission fluid, anti-freeze	

*These pumps have been superseded and will be discontinued in the near future. See recommended replacements above.

Diaphragm Pumps

Model	Body Materials (Wetted)	Diaphragm / Ball Material	Air Inlet NPT (F) in	Fluid Inlet / Outlet Material in	Max Flow gpm	Compatible Fluids
1/2" PORTS						
66605J-322	Polypropylene	Nitrile	1/4"	1/2"	13	Windshield fluid, motor / gear oil, transmission fluid, anti-freeze
66605J-388	Polypropylene	Polyurethane	1/4"	1/2"	13	Windshield fluid, motor / gear oil, transmission fluid, anti-freeze
1" PORTS						
666100-344-C	Aluminum	Teflon	1/4"	1"	35	Windshield fluid, motor / gear oil, transmission fluid, anti-freeze, solvents
666100-362-C	Aluminum	Nitrile / acetal	1/4"	1"	35	Windshield fluid, motor / gear oil, transmission fluid, anti-freeze
666100-3C9-C	Aluminum	Hytrel	1/4"	1"	35	Windshield fluid, motor / gear oil, transmission fluid, anti-freeze
666100-322-C	Aluminum	Buna	1/4"	1"	35	Windshield fluid, motor / gear oil, transmission fluid, anti-freeze
650717-C	Aluminum	Viton / acetal	1/4"	1"	29	Fuel (UL 79 approved)
1-1/2" PORTS						
666150-362-C	Aluminum	Nitrile / acetal	1/2"	1-1/2"	90	Windshield fluid, motor / gear oil, transmission fluid, anti-freeze
650718-C	Aluminum	Viton / acetal	1/2"	1-1/2"	75	Fuel (UL 79 approved)
2" PORTS						
666250-9C9-C	Aluminum	Hytrel	3/4"	2"	172	Windshield fluid, motor / gear oil, transmission fluid, anti-freeze
650719-C	Aluminum	Viton / acetal	3/4"	2"	105	Fuel (UL 79 approved)

650715-C

This 1:1 ratio pump has dual inlets to allow simultaneous pumping and blending of anti-freeze and water.



Specialty Application Pumps Specifications

Model	Application	Manifold Material	Diaphragm and O-Ring Material	Air Inlet NPT (F) in (mm)	Fluid Outlet NPT / F in (mm)	Max gpm (L/min)	Package Includes
1/2" PORTS							
612999-5	Waste oil evacuation	Polypropylene	Nitrile	1/4" (6)	1/2" (13)	11 (42)	Wall mount, inlet and outlet fluid hoses
612999-6	Waste oil evacuation	Polypropylene	Nitrile	1/4" (6)	1/2" (13)	11 (42)	Hanging bracket and outlet hose
1" PORTS							
650715-C	50/50 mix of anti-freeze and water	Aluminum	Nitrile	1/4" (6)	1" (25)	35 (133)	Pump only
612999-3	50/50 mix of anti-freeze and water	Aluminum	Nitrile	1/4" (6)	1" (25)	35 (133)	Wall mount, siphon tubes, material hoses
612999-4	Waste oil evacuation	Aluminum	Nitrile	1/4" (6)	1" (25)	35 (133)	Wall mount, inlet and outlet fluid hoses
613201-2-C	Calcium chloride tire filling	Aluminum	Neoprene	1/4" (6)	1" (25)	35 (133)	Inlet and outlet hoses, strainer, 8' suction hose, control handle, check valve

Ingersoll Rand Ultra-duty Hose Reels

Fully Redesigned with You in Mind

The new Ingersoll Rand ultra-duty hose reels offer improved strength and durability in a hose reel design. The versatile guide arm adjusts for convenient wall, floor, and ceiling mounting positions. Models are available for air, water, oil, and fluid service. The Safety-Reel design (SR models) features a controlled retraction mechanism to reduce personal property damage and to improve operator safety.

Features and Benefits

- Safety-Reel models feature 80% slower retraction to reduce personal property damage and improve operator safety
- Spun steel disc design for added strength and durability
- Containerized spring motor for fast and convenient maintenance
- Solid steel axle with precision bearings for smooth rotation

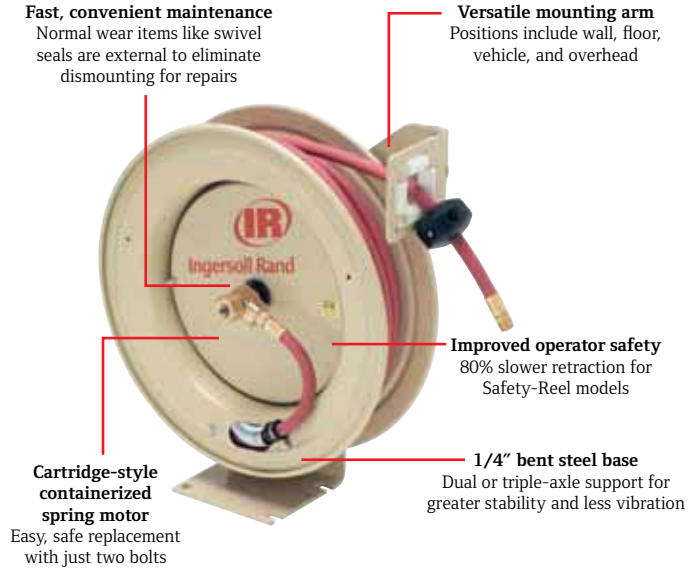

Ultra-duty Hose Reels

Model	Hose ID in (mm)	Inlet / Outlet NPT in (mm)	Length ft (m)	Flow psi (bar)	Weight lb (kg)
ULTRA-DUTY					
LOW-PRESSURE — AIR / WATER					
7UL3035	3/8" (9)	3/8" (9)	35' (11)	300 (21)	38 (17)
7UL3050	3/8" (9)	3/8" (9)	50' (15)	300 (21)	43 (20)
7UL3050-SR	3/8" (9)	3/8" (9)	50' (15)	300 (21)	43 (20)
7UL4030	1/2" (13)	1/2" (13)	30' (9)	300 (21)	45 (20)
7UL4050	1/2" (13)	1/2" (13)	50' (15)	300 (21)	48 (24)
7UL4050-SR	1/2" (13)	1/2" (13)	50' (15)	300 (21)	48 (24)
MEDIUM-PRESSURE — OIL / FLUID					
7UM4025	1/2" (13)	1/2" (13)	25' (8)	2,500 (172)	49 (23)
7UM4025-SR	1/2" (13)	1/2" (13)	25' (8)	2,500 (172)	49 (23)
7UM4050	1/2" (13)	1/2" (13)	50' (15)	2,500 (172)	67 (30)
7UM4050-SR	1/2" (13)	1/2" (13)	50' (15)	2,500 (172)	67 (30)
HIGH-PRESSURE — GREASE					
7UH3025	3/8" (9)	3/8" (9)	25' (8)	4,000 (276)	49 (22)
7UH3025-SR	3/8" (9)	3/8" (9)	25' (8)	4,000 (276)	49 (22)
7UH3050	3/8" (9)	3/8" (9)	50' (15)	4,000 (276)	65 (30)
7UH3050-SR	3/8" (9)	3/8" (9)	50' (15)	4,000 (276)	65 (30)

Note: All models supplied with hose.

Ingersoll Rand Supreme-duty Hose Reels

The supreme-duty series is designed for vehicle or heavy-duty applications requiring extra life and enhanced durability. Dual pedestal design offers triple-axle support points for improved strength and stability. Models are available for air, water, and fluid service. The Safety-Reel design (SR models) feature a controlled retraction mechanism to reduce personal property damage and to improve operator safety.

Features and Benefits

- Triple-axle support
- Dual-pedestal design for vehicle applications
- Spun steel disc design for added strength and durability
- Safety-Reel feature 80% slower retraction to reduce personal property damage and improve operator safety
- Adjustable guide arm for wall, floor, and ceiling mounting positions.

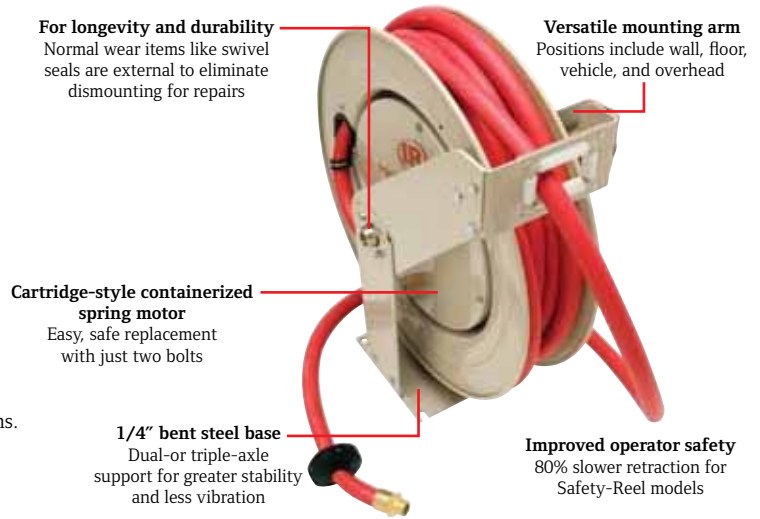

Supreme-duty Hose Reels

Model	Hose ID in (mm)	Inlet / Outlet NPT in (mm)	Length ft (m)	Flow psi (bar)	Weight lb (kg)
SUPREME-DUTY					
LOW-PRESSURE — AIR / WATER					
7SL3050-SR	3/8" (9)	3/8" (9)	50' (15)	300 (21)	61 (28)
7SL3075-SR	3/8" (9)	3/8" (9)	75' (23)	300 (21)	82 (37)
7SL4050-SR	1/2" (13)	1/2" (13)	50' (15)	300 (21)	63 (29)
7SL4075-SR	1/2" (13)	1/2" (13)	75' (23)	300 (21)	82 (37)
MEDIUM-PRESSURE — OIL / FLUID					
7SM4050-SR	1/2" (13)	1/2" (13)	50' (15)	2,500 (172)	77 (35)
HIGH-PRESSURE — GREASE					
7SH1100-SR	1/4" (6)	1/4" (6)	100' (30)	5,000 (345)	104 (47)

Note: All models supplied with hose.

Model	AWG Rating	Max Amp Rating amps	Voltage Rating volts	Length ft (m)	Weight lb (kg)	Notes
AUXILIARY REELS						
ELECTRIC CORD						
7E16050A-SR	16 GA	13	115	50 (15)	36 (16)	with plug
7E16050D-SR	16 GA	13	115	50 (15)	37 (17)	with light

Note: All models supplied with hose.

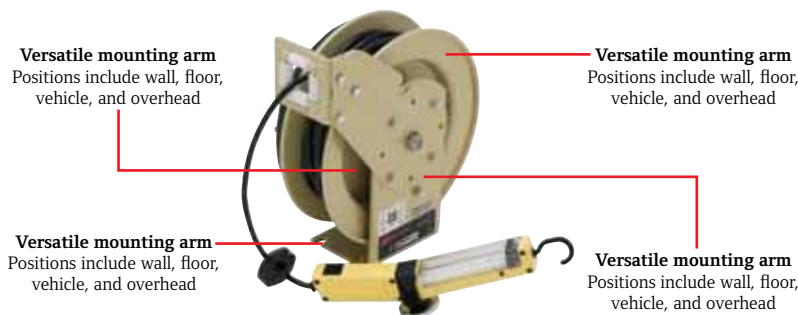

Ingersoll Rand Heavy-duty Hose Reels

Model	Performance Rating	Max Pressure	Hose Length ft	Hose ID in	Inlet / Outlet NPT	Dimensions (in)			Spool Material	Use
						Length in	Width in	Height in		
LOW-PRESSURE HOSE REELS										
6332	Heavy-duty	300	35'	1/2"	3/8" / 1/2"	17.75"	7"	20.37"	Composite	Air, water, compatible solvents
6338	Heavy-duty	300	35'	3/8"	3/8" / 3/8"	17.75"	7"	20.37"	Composite	Air, water, compatible solvents
6358	Heavy-duty	300	50'	3/8"	3/8" / 3/8"	17.75"	7"	20.37"	Composite	Air, water, compatible solvents
6358G	Heavy-duty	300	50'	3/8"	3/8" / 3/8"	17.75"	7"	20.37"	Composite	Air, water, compatible solvents

6358

Hose Reel

Low-pressure

This composite hose reel provides excellent durability at a great value. All composite reels are made of a tough glass-filled material combined with a strong steel base.



Hose Reel Accessories



Accessory	Model	Compatible With	Features
OH mounting bracket	7001	Ultra-duty	Overhead mounting bracket for I or H beam, 5" x 6" flange
OH mounting bracket	7009	Supreme-duty	Overhead mounting bracket for I or H beam, 8" x 9" flange
Wall-mount swing bracket	7002	Ultra-duty	Swing bracket (180°) for vertical mounting
Floor-mount swivel bracket	7003	Ultra-duty and supreme-duty	Swivel bracket (345°) for horizontal mounting
Ceiling-mount bracket, required with 7005	7004	Ultra-duty	Easy installation bracket; reel slides in and out for easy overhead mounting; must be ordered with 7005 for I or H beam installation
I or H beam adapter, requires 7004	7005	Ultra-duty	Easy installation bracket; I or H beam adapter; must be ordered with 7004.
Wall-mount swing bracket	7006	Supreme-duty	Vertical mounting bracket (180°); powdercoated crinkle black
Reelcraft adapter plate	7007		Custom adapter bracket for Reelcraft 4000, 5000, 5806, and 7000 Series 3" x 5" and 4" x 5" base patterns
Graco adapter plate	7008		Custom adapter bracket for Graco 500 Series 3" x 5" and 4" x 5" base patterns

Control Handles

Non-metered Fluid Control Handles

Model	Description	Max Working Pressure psi (bar)	Fluid Inlet NPT (F) in	Fluid Outlet
MOTOR OIL, GEAR OIL, TRANSMISSION FLUID				
HIGH-VOLUME				
635193	Has flexible rubber hose with a non-drip nozzle; use with 1:1 and 3:1 pumps; non-drip tip	600 (41)	3/4"	71893
635395-2	Has flexible rubber hose with non-drip nozzle; use with 5:1 and 9:1 pumps; non-drip tip	900 (63)	3/4"	71893
STANDARD-VOLUME				
635392	Has flexible rubber hose, built-in swivel and filter, and non-drip nozzle; non-drip tip	1,000 (69)	1/2"	60164
635399	Has flexible rubber hose, built-in swivel, and right-angle non-drip nozzle; non-drip tip	1,000 (69)	1/2"	70790
WATER, ANTI-FREEZE				
635129	Radiator bib	300 (21)	1/4"	Non-drip tip



635193



635399



635392

Digital, Metered Fluid Control Handles

Our new metered control handle features a patented oval gear wheel design for precise reliable measurement. Its digital LCD readout operates on two standard alkaline batteries.

- Lightweight
- Precise
- Fast reset
- Totalizes

Model	Max Flow Rate gpm (L)	Meter / Totalizing Increments	Max. Working Pressure psi (bar)	Fluid Inlet NPT (F) in	Fluid Outlet
METERED, RIGID NOZZLE MODELS					
635390-11	4 (15)	pt / gal	1,000 (69)	1/2"	Non-drip tip
635390-22	4 (15)	qt / gal	1,000 (69)	1/2"	Non-drip tip
635390-33	4 (15)	L / L	1,000 (69)	1/2"	Non-drip tip
NON-METERED, RIGID NOZZLE MODELS (HANDLE AND NOZZLE ONLY)					
635391-11	4 (15)	N/A	1,000 (69)	1/2"	Non-drip tip
METERED, FLEXIBLE NOZZLE MODELS					
635390-1	4 (15)	pt / gal	1,000 (69)	1/2"	Non-drip tip
635390-2	4 (15)	qt / gal	1,000 (69)	1/2"	Non-drip tip
635390-3	4 (15)	L / L	1,000 (69)	1/2"	Non-drip tip
NON-METERED, FLEXIBLE NOZZLE MODELS (HANDLE AND NOZZLE ONLY)					
635391-1	4 (15)	N/A	1,000 (69)	1/2"	Non-drip tip
METER ONLY					
635190-1	4 (15)	pt / gal	1,000 (69)	1/2"	
635190-2	4 (15)	qt / gal	1,000 (69)	1/2"	
635190-3	4 (15)	L / L	1,000 (69)	1/2"	
METER, CONTROL HANDLES (W/OUT NOZZLES)					
635390-10	4 (15)	pt / gal	1,000 (69)	1/2"	
635390-20	4 (15)	qt / gal	1,000 (69)	1/2"	
635390-30	4 (15)	L / L	1,000 (69)	1/2"	



635390-X



635390-XX



635391-11

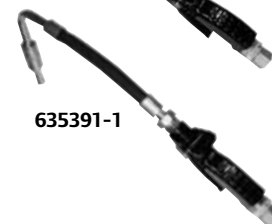

635391-1



635190-X

Order protective boot 74066 separately.

Metered Fluid Control Handles

Model	Units of Measure	Totalizing Increments	Working Pressure psi	Inlet Size in	Fluid Outlet
PRESET, DIGITAL METERED FLOW CONTROL					
Preset unit automatically shuts off when set quantity of fluid is delivered and meter indicator returns to zero. Totalizer registers up to 9,999 units.					
635360-2	Quarts	Gallons	1,000 (69)	1/2"	Non-drip flex extension
635360-22	Quarts	Gallons	1,000 (69)	1/2"	Non-drip rigid extension
635360-3	Liters	Liters	1,000 (69)	1/2"	Non-drip flex extension
635360-33	Liters	Liters	1,000 (69)	1/2"	Non-drip rigid extension
PRESET, METERED FLOW CONTROL					
Preset unit automatically shuts off when set quantity of fluid is delivered and meter indicator returns to zero. Totalizer registers up to 9,999 units.					
635364	Quarts, from 1 to 60	Gallons	1,000 (69)	1/2"	Non-drip tip, 9/16" diameter
635365	Gallons, from 1 to 60	Gallons	1,000 (69)	1/2"	Non-drip tip, 9/16" diameter
635367	Liters, from 1 to 60; auto shut off	Liters	1,000 (69)	1/2"	Non-drip tip, 9/16" diameter



635360-2



635365

Non-drip Nozzle / Hose

Model	Description	Fluid Inlet NPT (M) in	Length in (mm)	Max Working Pressure psi (bar)
MOTOR OIL, GEAR OIL, TRANSMISSION FLUID				
629212	Non-drip nozzle / hose	3/4"	12" (305)	900 (62)
629226	Non-drip nozzle / hose	1/2"	11" (279)	900 (62)
629516	Non-drip nozzle / hose	1/2"	13" (330)	1,000 (69)
629521	Right-angle nozzle / hose	1/2"	15" (381)	1,000 (69)
6786	Right-angle, rigid, non-drip nozzle	1/4"	6-1/2" (165)	1,000 (69)
60798	Rigid, non-drip nozzle	1/2"	5-1/2" (133)	1,000 (69)
NOZZLE, FLEXIBLE HOSE, WITH NON-DRIP TIP				
629245-1	Flexhose, non-drip tip	1/2"	15" (381)	1,000 (69)
NOZZLE, RIGID TUBE, WITH NON-DRIP TIP				
629245-2	Rigid tube, non-drip tip	1/2"	13" (330)	1,000 (69)



629226



629516



629521



6786

Control Handles Accessories

High-pressure Grease Control Handles

Model	Description	Max Working Pressure psi (bar)	Fluid Inlet NPT (F) in	Fluid Outlet in
GREASE CONTROL HANDLES				
636101	Dispenses lubrication at line pressure for lubricating grease fittings. Does not include nozzle or hydraulic coupler. For applications requiring high-flow capacity. Remove the 1/8" (M) x 3/8" (M) adaptor for 3/8" (F) porting.	7,500 (517)	3/8" (F)	11/16 – 16" (M) or 1/8" NPT (F)
636111	Dispenses lubricant at line pressure for lubricating grease fittings. Includes inlet material filter and curved nozzle with hydraulic coupler. Remove the 1/8" (M) x 3/8" (M) adaptor for 3/8" (F) porting.	7,500 (517)	1/8" (M) or 3/8" (F)	Hydraulic coupler
636103	High-pressure booster handle delivers line pressure for normal lubrication. Trigger booster feature delivers 10,000 psi (689 bar) to break loose tougher fittings. Includes curved nozzle with hydraulic coupler, inlet material filter and manual pressure vent for easy disconnection. WARNING: Do not use with whip hose.	7,500 (517)	1/8" (M) or 3/8" (F)	Hydraulic coupler
WHIP HOSES FOR GREASE CONTROL HANDLES*				
629742	Extra-long, wire braid (624201-02) whip hose with hydraulic coupler and swivel. Overall length 29-1/2" (749 mm). For use with coupler 636111 high-pressure control handle. Allows operator to access hard-to-reach fittings.	5,000 (345)	1/8" (F)	hydraulic

*WARNING: Not for use with 636103 high-pressure booster handle.

Water, Anti-freeze, Windshield Fluid Control Handle

Model	Description
WATER, ANTI-FREEZE, WINDSHIELD FLUID	
635129	Fluid dispensing nozzle — 635129 bib with trigger 1/4" NPTF inlet, zinc die casting with brass and nitrile seals for water or oil service; radiator type bib has 1/4" fluid inlet and non-drip tip



636101

636111

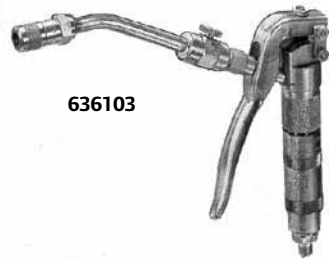

636103



629742



635129

Hand-held Grease Guns

Model	Max Input Pressure psi	Max Output Pressure psi	Grease Coupler	Included
HAND-HELD GREASE GUNS				
550	N/A	10,000	4-jaw	6" extension and 18" whip hose
570	N/A	7,500	4-jaw	4" extension and 18" whip hose
590	150	6,000	4-jaw	6" extension
5190	150	6,000	4-jaw	6" extension

550

Hand-held Grease Gun

This heavy-duty grease gun has a comfort grip handle and can output up to 10,000 psi. Features include an easy-to-load locking plunger and ergonomic T-handle. A filler nipple and air vent are also included. The 550 comes standard with a 6" angle extension and an 18" whip hose, both with a 4-jaw coupler.



570

Hand-held Grease Gun

This heavy-duty grease gun has a comfort grip handle and can output up to 7,500 psi. Features include an easy-to-load locking plunger, an ergonomic T-handle, a filler nipple, and air vent. The 570 comes standard with a 3-1/2" straight extension and an 18" whip hose, both with a 4-jaw coupler.



590

Hand-held Grease Gun

This heavy-duty grease gun has a 40:1 pressure ratio, an easy-to-load locking plunger, an ergonomic T-handle, a filler nipple, and air vent. The 590 comes standard with a 6" angle extension with a 4-jaw coupler.

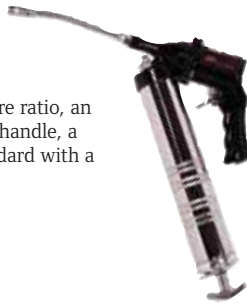

5190

Hand-held Grease Gun

A new, ergonomic design, the 5190 grease gun has a handle that can be swiveled 180° from the cartridge. The larger handle improves comfort while still packing a 40:1 pressure ratio.



Grease Guns



Try the Ingersoll Rand push-type hand grease gun for flush-type fittings. It holds up to 3 oz of grease. For more information, turn to page 117.

Self-evacuating Waste Oil Caddies

We offer a fast and affordable way to transfer used oil to any bulk storage tank using compressed air. Ingersoll Rand self-evacuating waste oil caddies eliminate the need for waste oil pumps. Reduce drainage downtime and dangerous spills while increasing your productivity.

Features and Benefits

- Compatible with most existing shop air systems, unlike many other caddies that require restricted psi
- Offers increased mobility with casters on all corners, two that lock
- Increases productivity with shorter drain time, and more time in the bay
- Comes standard with regulator, gauge, and either a 6' hose with nozzle or a 3/4" cam coupler
- Minimizes spills with an automatic ball check valve in the down tube
- Compatibility — Our oil caddies will work with existing shop air systems up to 70 psi
- Dependability — Tank empties in minutes, allowing you to get back to your work faster
- Safety — A specially designed automatic ball check valve prevents oil release when emptying tank



62131

Self-evacuating Oil Caddy

- 21-gallon tank
- Comes complete with 6' drainage hose and nozzle



67384

Self-evacuating Oil Caddy

- 21-gallon tank
- Comes standard with 3/4" cam coupler



Self-evacuating Oil Caddy

Model	Max Inlet Pressure psi (bar)	Tank Capacity gal (L)	Height in (m)	Fluid Outlet	Air Inlet in (mm)
FRESH OIL CADDY					
62131	150 (10)	21 (80)	49" – 70" (1.3 – 1.8)	6' hose with nozzle	1/4" (6)
67384	150 (10)	21 (80)	49" – 70" (1.3 – 1.8)	3/4" cam coupler	1/4" (6)

Accessories

Model	Type	Description	Compatibility
KITS, FUNNELS, AND TRAYS			
621603-6	Connection kit	Includes 6' waste oil hose with female 3/4" coupler and air supply line	Use with 67384
96268	Transmission funnel	22" x 35" funnel fits standard 61231 and 61235 funnels	Fits 62131
96548	Transmission funnel	24" x 35" transmission funnel fits standard 67384 units	Fits 67384
96269	Tool tray	Polypropylene tool tray holds tools, filters, funnels, etc; connects to down tube and handle	Fits 62131, 61235, 67384

Fresh Oil Caddy

The 24-gallon Ingersoll Rand fresh oil caddy system provides a cost effective solution for dispensing synthetic oil. These caddies are easy to use and require minimal maintenance. The fresh oil caddy system eliminates the need to add costly bulk storage tanks for oils and fluids. Specialized fluids, such as 5W-20 synthetic motor oils, can now be stored in a fresh oil caddy system and wheeled to the vehicle to be dispensed.

Features and Benefits

- Our fresh oil caddy has the mobility to go where your job takes you
- Increases productivity by increasing mobility
- Uses a 3:1 piston pump with air filter / regulator
- Dispenses fluids through a 6' hose with 1/2" diameter
- Includes a digital dispensing meter (totalizing)
- Improves mobility around the shop with 6" front casters

612999-24

Fresh Oil Caddy

- 24-gal fresh oil caddy with dispensing nozzle

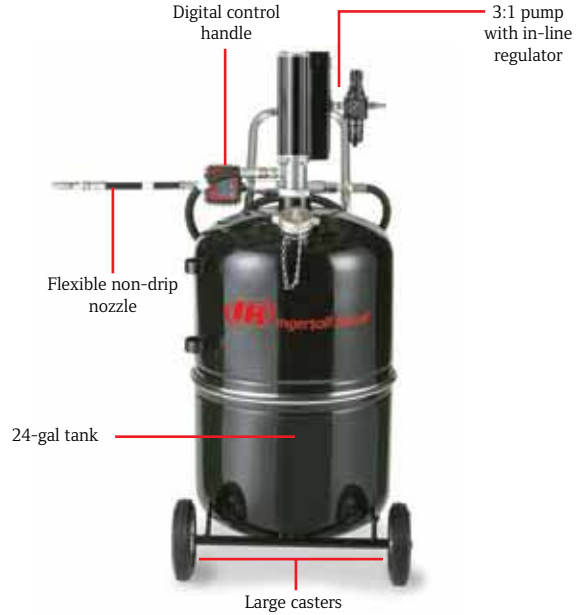

Fresh Oil Caddy

Model	Capacity gal (L)	Air Inlet in (mm)	Max Fluid Outlet in (mm)	Working Flow Rate gpm (L/min)	Free Flow Rate gpm (L/min)	Operating Air Pressure psi (bar)
FRESH OIL CADDY						
612999-24	24 (91)	1/2" (13)	1/2" (13)	6 (23)	9 (34)	40 – 100 (3 – 7)

Hand-operated Pumps

Grease NLGI #0 thru #3

Model	Description
LUBRICATION PUMPS, 35-LB, DRUM COVER TYPE	
611016	Ball joint lubricator — Can deliver up to 1/4-oz of lubricant per stroke. Includes 72006 drum cover, 622511-10 hose assembly, 640095-3-B follower plate and 72806 booster control handle. Control handle capable of generating up to 7,500 psi.



611016

Motor Oil, Gear Oil, Transmission Fluid

Model	Ratio	Description
MOTOR OIL, GEAR OIL, TRANSMISSION FLUID		
5-GAL		
611170	Adjustable	Capable of high-volume delivery. Includes 621597-5 hose / dispensing, 2:1, 4:1, 7:1 nozzle assembly (5' (1.5 m), 1/2" ID hose) and 72006 drum cover.



611170

Container not included.

Accessories



Ingersoll Rand offers an extensive line of accessories to match your tools with the requirements of every job. These accessories put the reliability and quality of Ingersoll Rand behind every job you do.



Ingersoll Rand Lubricants

It goes without saying that proper lubrication of any tool is essential if you want the tool to last. By lubricating your air tools, you'll prolong the life of tool motors, governors, clutches, and other important impact mechanisms.

Ingersoll Rand offers a complete line of specialized oils and greases to complement our full line of air tools.

Air Care Kits

Part Number	Description
AIR CARE KITS	
67-LBK1	Angle grinder care kit includes 10Z4 oil, 4 oz 67 grease, grease gun
105-LBK1	Metallic housings Impactool care kit includes 10Z4 oil, 4 oz 105 grease, grease gun
115-LBK1	Composite housings Impactool care kit includes 10Z4 oil, 4 oz 115 grease, grease gun



105-LBK1

Air Tool Oils

Part Number	Description	Size
AIR TOOL OILS		
63Z4	#63 oil for Cyclone wick lubrication	4 oz
10Z4	Class 1 #10 oils for use with percussive, assembly, Impactool	4 oz
10G	Class 1 #10 oils for use with percussive, assembly, Impactool	1 gal
10P	Class 1 #10 oils for use with percussive, assembly, Impactool	1 pt
10G55	Class 1 #10 oils for use with percussive, assembly, Impactool	55 gal
50P	Class II lubricant, #50 oil for use with grinders, Impactool, hoists, winches	1 pt
50G	Class II lubricant, #50 oil for use with grinders, Impactool, hoists, winches	1 gal
62 1 Gal	Class II #62 oil for hoist and winch gear boxes	1 gal



10Z4



10G



10P



LUB-POP

Greases

Part Number	Description	Grease #	Size
GREASES			
23-1 LB	For the gearing of drills	23	1 lb
28 1 LB	For screwdriver gearing and clutches; drills, grinders, saws; tie tampers grease	28	1 lb
66 1 LB	For slow-speed, high-torque angle heads	66	1 lb
66 8 LB	For slow-speed, high-torque angle heads	66	8 lb
67-4T	For high-speed, high-temp angle heads (green)	67	4 oz
67-1 LB	For high-speed, high-temp angle heads (green)	67	1 lb
67 8 LB	For high-speed, high-temp angle heads (green)	67	8 lb
70 1 LB	For large piston motors and gear cases	70	1 lb
70 8 LB	For large piston motors and gear cases	70	8 lb
77-1 LB	For grinder angle heads	77	1 lb
80 1 LB	For bearings on sump pumps	80	1 lb
80 8 LB	For bearings on sump pumps	80	8 lb
90-14 oz	For gear heads and tube nut wrenches	90	14 oz
100 1 LB	Standard-duty Impactool grease	100	1 lb
100 8 LB	Standard-duty Impactool grease	100	8 lb
105-4T-6	Metallic housing Impactool grease	105	4 oz
105-1 LB	Metallic housing Impactool grease	105	1 lb
105-8 LB	Metallic housing Impactool grease	105	8 lb
115-4T-6	Composite housing Impactool grease	115	4 oz
115-1 LB	Composite housing Impactool grease	115	1 lb
150-1 LB	For impact mechanisms with swinging weight	150	1 lb
150-8 LB	For impact mechanisms with swinging weight	150	8 lb
170-1 LB	Premium impact grease for high temps, used with impact mechanisms	170	1 lb



100 1 LB



105-4T-6

Lubrication Kits

Part Number	Description	Quantity
LUBRICATION KITS		
LUB-POP	Point-of-purchase display includes (3) 10G, (5) 10P, (24) 10Z4, (6) 100-1LB, (8) 105-LBK1, (8) 115-LBK1, (1) case 10Z4, (1) case hang tags	1
10Z4-MB24	Case of 10Z4; countertop display	24
10P-MB5	Case of 10P; countertop display	5
10G-MB3	Case of 10G; countertop display	3
100-MB6	Case of #100 grease; countertop display	6
105LBK1-MB8	Case of 105-LBK1; countertop display	8
115LBK1-MB8	Case of 115-LBK1; countertop display	8

Grease Guns and Accessories

Part Number	Description
GREASE GUNS	
P25-228	Push-type hand grease gun for hydraulic-type fittings, holds up to 3 oz of grease
R000A2-228	Push-type hand grease gun for flush-type fittings, holds up to 3 oz of grease
GREASE TUBE HEAD	
GTH-1	Grease gun used with Ingersoll Rand 4 oz tube of grease
GREASE GUN COUPLERS	
636020	Grease gun coupler
636024	Grease gun adaptor



P25-228



GTH-1



636020

Gloves

With this line of industry-leading work gloves from Ingersoll Rand, you can pair up the industry's toughest tools — ours — with gloves that offer the utmost in protection, comfort, and performance.

Part Number	Description	Quantity	Size
IR-G SERIES			
IR-GL-1	Ingersoll Rand mechanic gloves	1 pair	Large
IR-GXL-1	Ingersoll Rand mechanic gloves	1 pair	Extra-large
TGSL-G SERIES			
TGSL-GL-1	ThunderGun impact gloves	1 pair	Large
TGSL-GXL-1	ThunderGun impact gloves	1 pair	Extra-large
TNT-G SERIES			
TNT-GL-1	Titanium impact gloves	1 pair	Large
TNT-GXL-1	Titanium impact gloves	1 pair	Extra-large

IR-G Series

- Provide protection during day-to-day jobs
- Machine washable Clarino® synthetic palm construction allows full finger dexterity and enhanced tool handling
- Spandex top ensures comfortable fit



Protection

TGSL-G Series

- Silicon gel palm padding reduces tool vibrations and minimizes fatigue
- Machine washable Clarino synthetic palm construction allows full finger dexterity and enhanced tool handling
- Airprene knuckle panel provides greater protection, ventilation, and comfort
- Looks great with the ThunderGun Impactool



Protection and comfort

TNT-G Series

- Silicon finger and thumb grippers enhance tool control
- Neoprene top offers impact protection while allowing increased comfort and dexterity
- 3 mm gel palm pads reduce hand fatigue
- Ideal for Ingersoll Rand titanium tools



Protection, comfort, and performance

MS Series Plugs and Couplers

Body Size in	NPT or Hose Stem ID in	Average Flow cfm*	NPT Part Number	Hose Stem ID Part Number
FEMALE PLUGS				
1/4"	1/8"	36	MSPF21	N/A
1/4"	1/4"	36	MSPF22	MSPH22
1/4"	3/8"	36	MSPF23	MSPH23
3/8"	1/4"	67	MSPF32	N/A
3/8"	3/8"	67	MSPF33	MSPH33
3/8"	1/2"	67	45ATH	MSPH34
1/2"	3/8"	126	MSPF43	N/A
1/2"	1/2"	126	MSPF44	MSPH44
1/2"	3/4"	126	MSPF46	N/A
MALE PLUGS				
1/4"	1/8"	36	MSPM21	N/A
1/4"	1/4"	36	MSPF22	MSPH22
1/4"	3/8"	36	MSPM23	MSPH23
3/8"	1/4"	67	MSPM32	N/A
3/8"	3/8"	67	PRPM33	MSPH33
3/8"	1/2"	67	MSPM34	MSPH34
1/2"	3/8"	126	MSPM43	N/A
1/2"	1/2"	126	MSPM44	MSPH44

*At 90 psig inlet and 10 psig pressure drop.

INDUSTRIAL INTERCHANGE

- Economical automatic-type, one-way shutoff coupler
- Easy, push-to-connect use

Female Plugs



Female NPT



Hose Stem ID



45ATH

Male Plugs



Male NPT



Hose Stem ID

Body Size in	NPT or Hose Stem ID in	Average Flow cfm*	Manual NPT Part Number	Automatic NPT Part Number	Hose Stem ID Part Number
FEMALE COUPLERS					
1/4"	1/4"	36	N/A	MSCF22	MSCH22
1/4"	3/8"	36	N/A	MSCF23	MSCH23
3/8"	3/8"	67	420ATH	MSCF33	MSCH33
3/8"	1/2"	67	440ATH	N/A	N/A
1/2"	1/2"	126	N/A	MSCF44	MSCH44
MALE COUPLERS					
1/4"	1/4"	36	N/A	MSCM22	MSCH22
1/4"	3/8"	36	N/A	MSCM23	MSCH23
3/8"	1/4"	67	N/A	4100ATH	N/A
3/8"	3/8"	67	430ATH	MSCM33	MSCH33
1/2"	1/2"	126	N/A	MSCM44	MSCH44

Female Couplers



Automatic NPT



Hose Stem ID



Manual NPT

Male Couplers



Automatic NPT



Hose Stem ID



4100ATH



430ATH

PR Series Plugs and Couplers

Body Size in	NPT in	Average Flow cfm*	Part Number
FEMALE THREAD COUPLERS			
1/4"	1/4"	32	PRSGF22
1/4"	3/8"	32	PRSGF23
3/8"	3/8"	64	PRSGF33
3/8"	1/2"	64	PRSGF34
1/2"	3/8"	147	PRSGF43
1/2"	1/2"	147	PRSGF44
1/2"	3/4"	147	PRSGF46
MALE THREAD COUPLERS			
1/4"	1/4"	32	PRSGM22
1/4"	3/8"	32	PRSGM23
3/8"	3/8"	64	PRSGM33
3/8"	1/2"	64	PRSGM34
1/2"	3/8"	147	PRSGM43
1/2"	1/2"	147	PRSGM44
1/2"	3/4"	147	PRSGM46
HOSE BARB COUPLERS			
1/4"	1/4"	32	PRSGH22
3/8"	1/4"	32	PRSGH23
3/8"	3/8"	64	PRSGH33
1/2"	3/8"	64	PRSGH34
3/8"	1/2"	147	PRSGH43
1/2"	1/2"	147	PRSGH44
5/8"	1/2"	147	PRSGH45
3/4"	1/2"	147	PRSGH46

*At 90 psig inlet and 10 psig pressure drop.

QUICK CONNECT DOUBLE-ACTION COMPOSITE SAFETY COUPLERS

Couplers

- Made of non-marring composite
- Safety coupler eliminates accidental disconnects
- Easy connect, disconnect
- Allows you to bleed hoses
- Shockproof and crush-resistant



Hose Barb Couplers



Female Thread Couplers



Male Thread Couplers

Body Size in	NPT in	Average Flow cfm*	Part Number
FEMALE THREAD CONNECTOR PLUGS			
1/4"	1/4"	N/A	PRPF22
1/4"	3/8"	N/A	PRPF23
3/8"	1/4"	N/A	PRPF32
3/8"	3/8"	N/A	PRPF33
1/2"	1/2"	N/A	PRPF44
MALE THREAD CONNECTOR PLUGS			
1/4"	1/4"	N/A	PRPM22
1/4"	3/8"	N/A	PRPM23
3/8"	1/4"	N/A	PRPM32
3/8"	3/8"	N/A	PRPM33
HOSE BARB CONNECTOR PLUGS			
1/4"	1/4"	32	PRPH22
3/8"	1/4"	32	PRPH23
3/8"	3/8"	64	PRPH33
1/2"	3/8"	64	PRPH34
1/2"	1/2"	147	PRPH44
5/8"	1/2"	147	PRPH45
3/4"	1/2"	147	PRPH46

*At 90 psig inlet and 10 psig pressure drop.

Connector Plugs

- Carbonitride steel with anti-corrosion protection
- Teflon coating on all male threads



Female Thread Connector Plugs



Male Thread Connector Plugs



Hose Barb Connector Plugs

Air Hose Nipples

Part Number	Hose Size in (mm)	Pipe Thread in
MALE PIPE THREAD		
IR78217	1/4" (6)	1/4"
IR30127	5/16" (8)	1/4"
AL-387	5/16" (8)	3/8"
R00-146	3/8" (10)	1/8"
D01-14	3/8" (10)	1/4"
IR6225	3/8" (10)	3/8"
A01-46	1/2" (13)	3/8"
D02-455	1/2" (13)	1/2"
A03-46	3/4" (19)	1/2"
J3-581	3/4" (19)	3/4"
P35-46	1" (25)	1"
CN-20-S	2" (51)	2"
FEMALE PIPE THREAD		
R1-47	5/16" (8)	3/8"
R00-147	3/8" (10)	3/8"

Male Pipe Thread



AL-387



R00-146



D01-14



IR6225



A01-46



A03-46

Female Pipe Thread



R00-147

Swivels and Adapters

Part Number	Thread Size in	Airflow cfm*	Description
SWIVEL-IT SWIVELS			
ASA-1/4	1/4"	0 - 25	Adjustable Swivel-It
ASC-1/4	1/4"	0 - 33	Non-marring Swivel-It
AS-3/8	3/8"	0 - 45	Standard Swivel-It
AS-1/2	1/2"	0 - 65	Standard Swivel-It

Part Number	Size NPT in	Description
SWIVELS AND ADAPTERS		
636077	1/8" (M) x 1/8" (F)	Z swivel
636086-B	1/4" (M) x 1/4" (F)	Z swivel
636087-B	1/4" (M) x 1/4" (F) with filter element	Z swivel
635106	1/2" (F) x 3/8" (M)	Z swivel
636075	1/8" (M) x 1/8" (F)	Straight swivel
636085	3/8" (M) x 3/8" (F)	Straight swivel
635117	1/2" (M) x 1/2" (F)	Straight swivel
635108	3/4" (M) x 3/4" (F)	Straight swivel
635107	3/8" (M) x 1/2" (F)	Straight swivel
3249	1/8" (F) x 1/8" (F)	Female adapter
676	1/8" (M) x 1/8" (M)	Male adapter

Swivel-It Swivels



ASC-1/4

Swivels and Adapters



636077



636075



635108



676

Hose Whips

Part Number	Hose ID in	Hose Length ft	Male End in	Female End in
HOSE WHIPS*				
R00H-130	1/4"	8'	1/8"	1/4"
RO-130	5/16"	8'	1/4"	3/8"
R1A-130	3/8"	8'	1/4"	3/8"
510-130	3/8"	8'	3/8"	3/8"

*250 psig max working pressure.

Consists of hose assembled with male hose nipple at one end and female hose nipple at the other end.



R00H-130

Fitting Kits — Polyurethane Coil Hoses

Part Number	Description
FITTING KITS*	
P14-RMS	1/4" NPT reusable male swivel fitting kit for 1/4" ID polyurethane hose
P38-RMS	3/8" NPT reusable male swivel fitting kit for 3/8" ID polyurethane hose
P14-RMR	1/4" NPT reusable male rigid fitting kit for 1/4" ID polyurethane hose
P38-RMR	3/8" NPT reusable male rigid fitting kit for 3/8" ID polyurethane hose
P12-RFR	1/2" NPT reusable female rigid fitting kit for 1/2" ID polyurethane hose
P12-RMS	1/2" NPT reusable male rigid fitting kit for 1/2" ID polyurethane hose

*125 psig working pressure @ 75° F.



P38-RMS



P12-RMS



P38-RMR

Premium Rubber Hose

Part Number	Size
PREMIUM RUBBER HOSE	
38016820	3/8" x 50'

- Premium rubber air hose, specifically designed for heavy-duty applications, such as industrial, maintenance, automotive, and/or construction
- 3/8" x 50' red hose with black Ingersoll Rand logo
- Black hose restrictors on each end provide a 300 psi working pressure and a 4:1 safety burst ratio

Polyurethane Coil Hoses

Part Number	Description
POLYURETHANE COIL HOSES	
P14-10	1/4" x 10' polyurethane coil hose, (1) 1/4" rigid, (1) 1/4" swivel fitting
P14-20	1/4" x 20' polyurethane coil hose, (1) 1/4" rigid, (1) 1/4" swivel fitting
P14-30	1/4" x 30' polyurethane coil hose, (1) 1/4" rigid, (1) 1/4" swivel fitting
P38-10	3/8" x 10' polyurethane coil hose, (1) 3/8" rigid, (1) 3/8" swivel fitting
P38-20	3/8" x 20' polyurethane coil hose, (1) 3/8" rigid, (1) 3/8" swivel fitting
P38-30	3/8" x 30' polyurethane coil hose, (1) 3/8" rigid, (1) 3/8" swivel fitting
P12-10R	1/2" x 10' polyurethane coil hose, (2) 1/2" reusable swivel fittings
P12-20R	1/2" x 20' polyurethane coil hose, (2) 1/2" reusable swivel fittings
P12-30R	1/2" x 30' polyurethane coil hose, (2) 1/2" reusable swivel fittings

Features

- Superior elasticity and coil memory mean a cleaner work environment
- Outstanding flexibility increases operator comfort
- 25% lighter than rubber hose, reducing operator fatigue
- Abrasion and kink resistance increase lifetime
- Tight coil diameter allows easy entry into confined spaces
- Non-marring surface won't harm work pieces
- Broad chemical resistance makes hoses suitable for most environments
- Better than 80% working length extends your work space
- Straight tails on both ends eliminate workstation tangles
- Reusable MNPT fittings allow field retrofits
- Thread sealant on all fittings provides for leak-free joints



Features

- 6-year warranty
- Longer life than PVC
- Reinforced innermost tube, resistant to the materials it is intended to convey
- Extended life bend restrictors
- Increased flexibility in cold temperatures
- Designed to withstand the harshest jobsite conditions
- Extended service life due to number of threads, spirals, and thickness of rubber tube



Spring Balancers

- 19 models to choose from
- Three different series to meet all balancing requirements
- Lifts ranging from 4-1/4' to 8.2'
- Covers weight balancing needs from 1 to 30 lb
- Made of rugged die-cast aluminum
- Safety locking device in case of spring breakage on medium-duty models
- Easy-to-use controls allow for accurate spring adjustment

Hose Reel Balancers

Part Number	Hose Nipple Size in	Extended cfm	Capacity lb (kg)	Lift ft (mm)
HOSE REEL BALANCERS				
BHR-8	1/4"	18.4	0.875 - 1.75 (0.397 - 0.794)	4-1/4' (1295)
BHR-15	1/4"	18.4	1.5 - 3.33 (0.68 - 1.51)	4-1/4' (1295)
BHR-25	1/4"	18.4	2.625 - 5.5 (1.191 - 2.495)	4-1/4' (1295)

Hose Reel Balancers



BHR-15

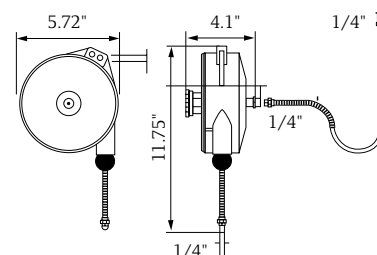

BHR Series

Light-duty Balancers

Part Number	Capacity lb (kg)	Weight Of Balancer lb (net-kg)	Lift ft (mm)
LIGHT-DUTY BALANCERS — 0.9 - 6.6 LB CAPACITY			
BLD1	0.9 - 2.2 (0.4 - 1)	1.3 (0.6)	5.2' (1600)
BLD2	2.2 - 4.4 (1 - 2)	1.3 (0.6)	5.2' (1600)
BLD3	4.4 - 6.6 (2 - 3)	1.3 (0.7)	5.2' (1600)

Light-duty Balancers



BLD1

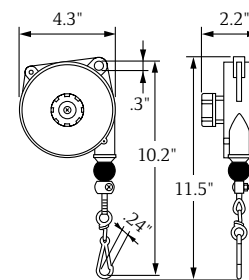

BHR Series

- Rotary hook
- Adjustable capacity and stroke limiting device
- Self-lubricating bushings
- Auxiliary safety suspension

Medium-duty Balancers

Part Number	Capacity lb (kg)	Weight of Balancer lb (net-kg)	Lift ft (mm)
MEDIUM-DUTY BALANCERS* SHORT CABLES			
BMDS-2	2.2 - 5.5 (1 - 2.5)	4.4 (2)	6.5' (2000)
BMDS-4	4.4 - 8.8 (2 - 4)	4.4 (2)	6.5' (2000)
BMDS-6	8.8 - 13.2 (4 - 6)	5.1 (2.3)	6.5' (2000)
BMDS-8	13.2 - 17.6 (6 - 8)	5.5 (2.5)	6.5' (2000)
LONG CABLES			
BMDL-4	4.4 - 8.8 (2 - 4)	6.4 (2.9)	8.2' (2500)
BMDL-6	8.8 - 13.2 (4 - 6)	7.1 (3.2)	8.2' (2500)
BMDL-8	13.2 - 17.6 (6.8 - 8)	7.7 (3.5)	8.2' (2500)
BMDL-10	17.6 - 22 (8 - 10)	8.2 (3.7)	8.2' (2500)
BMDL-12	22 - 30 (10 - 14)	8.8 (4)	8.2' (2500)
MEDIUM-DUTY LOCKING BALANCERS* LONG CABLES			
BMDLL-4	4.4 - 8.8 (2 - 4)	6.6 (3)	8.2' (2500)
BMDLL-6	8.8 - 13.2 (4 - 6)	7.3 (3.3)	8.2' (2500)
BMDLL-8	13.2 - 17.6 (6 - 8)	7.9 (3.6)	8.2' (2500)
BMDLL-10	17.6 - 22 (8 - 10)	8.4 (3.8)	8.2' (2500)

Medium-duty Balancers



BMDS-2

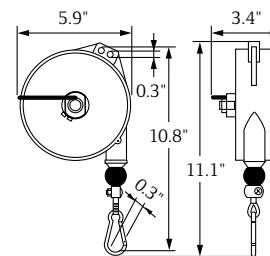

BMDS Series

Medium-duty Locking Balancers



BMDLL-10

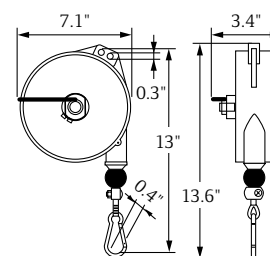

BMDL / BMDLL Series

*Larger sizes available upon request.

600 Series Blow Guns

Part Number	Description
600 SERIES	
600-S	Standard safety blow gun
600-SB	Booster safety blow gun
606-S	Safety blow gun with 6" extension
612-S	Safety blow gun with 12" extension
600 SERIES ACCESSORIES	
ST206	6" safety extension
ST212	12" safety extension
BLOW GUN TIPS	
ST10	Standard safety tip
ST11	Safety air booster tip

- Engineered to the highest level of quality and durability
- Available in standard 6" and 12" lengths
- Cushioned thumb grips maximize operator comfort

600 Series

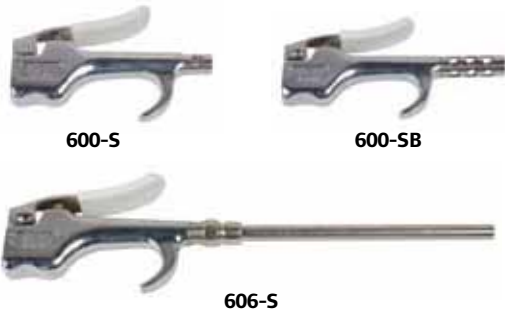

600 Series Safety Extensions



8338 Series Blow Guns

Part Number	Description
8338 SERIES	
8338	Standard tip gun; generates concentrated stream of air
8338-1	Safety blow gun generates cone of air
8338-2	Safety blow gun with rubber tip
8338 SERIES ACCESSORIES	
22101	Brass tip
22151	Rubber tip
22180-1	Standard tip
22180-2	Air shield tip
22180-3	3" extension tip
33970	10" extension tip

8338 Series



8338 Series



Air Jets and Nozzles

Part Number	Description	Air Consumption cfm (L/min)	Vacuum oz (g)
AIR JETS			
38038089	High-velocity air jet, 1/2" outlet	16.5 (467)	14 (396)
38038097	Adjustable air jet, 1/2" outlet	18 (509)	16 (453)
38038105	Air jet shim set	N/A	N/A
AIR NOZZLES			
38038113	Safety air nozzle, 1/8" NPTF	10 (283)	9 (257)
38038121	Safety air nozzle, 1/4" NPTF	17 (481)	16 (453)
38038139	Adjustable air nozzle, 1/8" NPTM	13 (368)	12 (340)
38038147	Air nozzle, 1/4" NPTF	14.7 (416)	13 (368)

Applications

- Parts cleaning
- Chip removal
- Part drying
- Liquid blow-off
- Part cooling
- Material conveying
- Part ejection
- Fiber conveying
- Air assist

Advantages

- Reduce compressed air cost
- 10 dBA average noise reduction
- Improved blow-off performance
- Compact
- Meet OSHA noise level requirements
- Meet OSHA pressure requirements

Air Jets



38038089



38038097



38038105

Air Nozzles



38038121



38038139



38038147

Soft-grip Safety Air Guns

Part Number	Description	Inlet NPT in	Extension
SOFT-GRIP SAFETY AIR GUN			
38435434	Soft-grip safety air gun with air nozzle	1/4"	N/A
38038154	Soft-grip safety air gun with air nozzle	1/4"	24" aluminum
38038162	Soft-grip safety air gun with air nozzle	1/4"	36" aluminum
38038170	Soft-grip safety air gun with air nozzle	1/4"	48" aluminum
38038188	Soft-grip safety air gun with air nozzle	1/4"	60" aluminum

- Ideal for hours of continuous use without fatigue
- Ergonomic design keeps the hand in a comfortable position and incorporates a large trigger that permits operation with one or more fingers
- Durable case aluminum body is suited for rugged industrial use and includes a convenient hanger hook for storage
- Inlets are 1/4" NPT



38038154



38435434

Adjustable Spot Cooler

Part Number	Description
ADJUSTABLE SPOT COOLER	
38037735	Adjustable spot cooler (one cold outlet)

Applications

- Adjusting thermostats
- Cooling solder
- Cooling machined plastics
- Setting hot melts
- Cooling welding horns
- Cooling molded plastics
- Electronic component cooling
- Cooling gas samples
- Cooling environmental chambers

Advantages

- No moving parts
- No electricity or chemicals
- Small, lightweight
- Low cost
- Maintenance-free
- Instant cold air
- Quiet — less than 75 dBA
- Swivel magnetic base
- Interchangeable generators



38037735

Pullers and Hoists

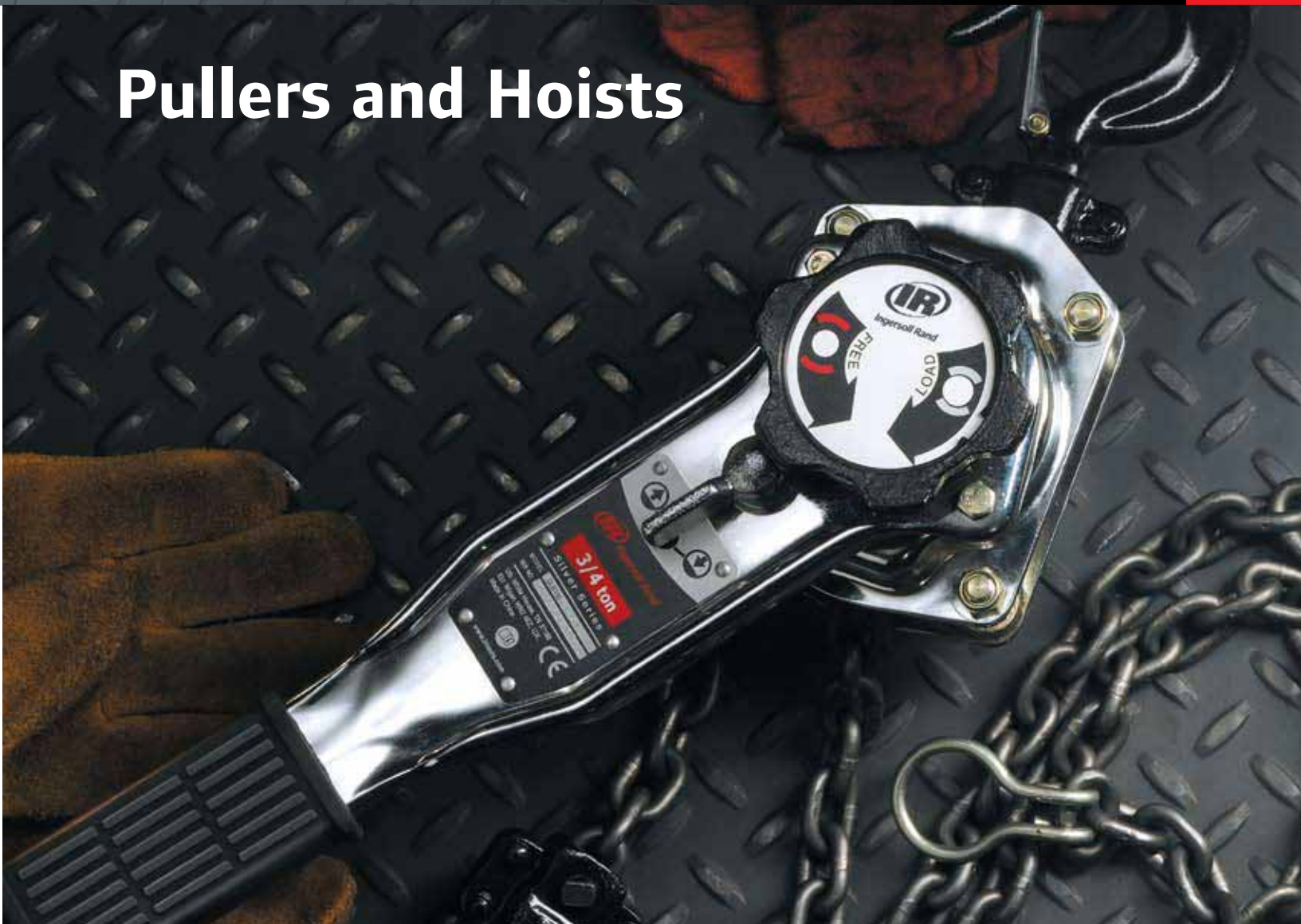

Ingersoll Rand pullers and hoists are designed to handle the tough pulling or lifting jobs, with minimal effort by the operator. Whether it's a low-, medium-, or heavy-duty job, you can trust our pullers and hoists to carry the load safely and easily.



P-Series Pullers

They'll pull up to 2,000 lb with no problem — and there's no hard work for you, either. Extremely strong and well-made, the Ingersoll Rand P-Series are high-quality, dependable wire rope pullers for low- and medium-duty pulling and lifting jobs.

- Made for superior strength with a steel frame and handle, alloy steel load hook, 1-piece cast aluminum drum, and solid steel drive and holding dog
- 4:1 design factor for lifting or pulling
- Long-lasting gears through the extra heavy Ingersoll Rand buttress tooth design

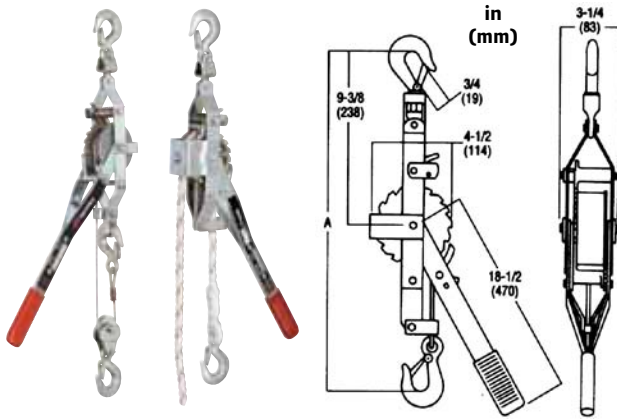

P-Series Pullers

C-Series Pullers

The C-Series includes rugged cast aluminum wire rope pullers designed to store more wire rope than all-steel ratchet pullers. With a rigged double line, they handle those long reach pulling or lifting jobs up to 3,400 lb with no problem.

- Extremely strong, with a solid cast steel drive and holding dog
- Heavy-duty cast aluminum drum and lightweight aluminum frame, alloy steel load hook with safety latches

Safe lowering is assured by the ratchet and pawl system. The gear teeth use the Ingersoll Rand buttress tooth design for additional strength and longer gear life.

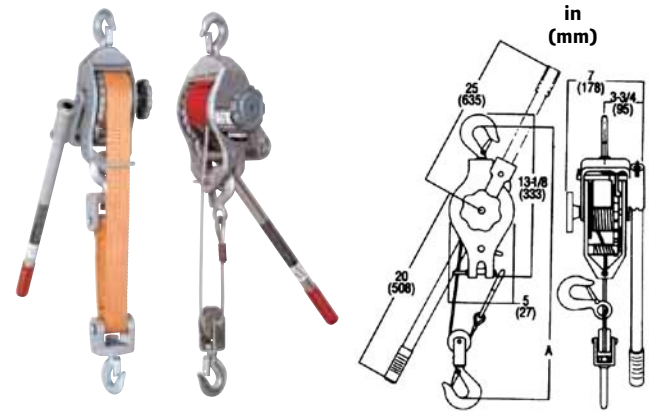

C-Series Pullers

Model	Number of Lines	Rated Capacity lb	Min Distance Between Hooks in	Lifting Distance ft	Cable Diameter in	Number of Hooks	Net Weight lb
P-SERIES PULLERS							
P15HA	Single	1,000	18"	15'	3/16"	2	8
P15D3HA	Single	1,000	18"	15'	3/16"	3	10
	Double	2,000	24"	7-1/2'	3/16"	3	10
C-SERIES PULLERS							
C400HA	Single	1,700	17"	20'	1/4"	3	16
	Double	3,400	22"	10'	1/4"	3	16
C400SA	Single	2,000	17"	12'	3/32" x 1-7/8"	2	16
	Double	4,000	22"	6'	3/32" x 1-7/8"	3	16

PT-8 Trolley Series

Plain 1/2 to 5 Metric Ton

Our plain trolley is rated for both manual or powered hoists, and has the versatility to fit most types of beams.

Standard features

- The 5:1 design factor allows the PT-8 Series to be used with both manual or powered hoists; meets pertinent U.S. (ASME / ANSI and CMAA), Canadian, and European standards
- The side plates, including the rail sweeps / drop stops, are made of cold-formed steel for strength, durability, and even load distribution
- The wheel axles are rivet-locked in place so they won't come loose — they are not knurled, welded, or modified bolts
- The wheels are cast iron — the universal tread fits both flat and tapered beams



Suspension bail is supplied with PT-8 trolleys only and is not required for most applications.

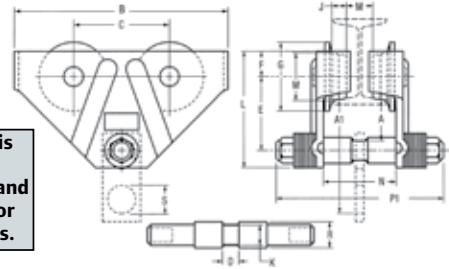

- Wheels run on sealed, "lubed-for-life" ball bearings; smoother rolling with less effort and less maintenance
- Wide hanger shaft assemblies allow PT-8 Series trolleys to fit almost any I beam, H beam, or patented track beam up to 8.06 in (205 mm) wide
- PT-8 Series trolley hanger shafts are designed to accept all hoist brands and have a squared out recess to accept round or squared hook shapes; the trolleys are painted black for universal coordination

Model	Trolley Capacity lb (kg)	Fits Beam Flange Width in (mm)	Beam Height in (mm)	Curve Radius in (mm)	Net Weight lb (kg)
PT-8 TROLLEY CONTRACTOR SERIES — SINGLE 8" (205 MM) HANGER SHAFT					
PPT005-8A	1,100 (500)	2.66" – 8.06" (68 – 205)	4" (102)	36" (914)	20 (9)
PT010-8A	2,200 (1000)	3" – 8.06" (76 – 205)	5" (127)	36" (914)	31 (14)
PT020-8A	4,400 (2000)	3.33" – 8.06" (85 – 205)	6" (152)	48" (1219)	56 (25)
PT030-8A	6,600 (3000)	4" – 8.06" (102 – 205)	8" (203)	60" (1524)	76 (35)
PT050-8A	11,000 (5000)	4.66" – 8.06" (118 – 205)	10" (254)	60" (1524)	113 (51)

Model	A in (mm)	A1** in (mm)	B in (mm)	C in (mm)	D in (mm)	E in (mm)	F in (mm)	G in (mm)	H in (mm)
PT-8 TROLLEY DIMENSIONS									
PT005-8A	2.5" (64)	6.125" (156)	10" (254)	4.5" (114)	1" (25)	4" (102)	1.12" (29)	3.43" (87)	2.25" (57)
PT010-8A	2.47" (63)	6.125" (156)	12.63" (321)	5.56" (141)	1.12" (29)	4.38" (111)	1.62" (41)	4.06" (103)	2.75" (70)
PT020-8A	2.47" (63)	6.06" (154)	14.88" (378)	6.5" (165)	1.18" (30)	5.18" (133)	1.31" (33)	5.75" (146)	4.25" (108)
PT030-8A	2.59" (66)	8.5" (216)	14.12" (358)	6.5" (165)	1.62" (41)	5.43" (138)	1.62" (41)	5.75" (146)	4.25" (108)
PT050-8A	2.56" (73)	8.5" (216)	15.44" (392)	6.75" (171)	1.31" (41)	5.75" (146)	2.25" (57)	6.18" (157)	4.38" (111)

Model	J in (mm)	K in (mm)	L in (mm)	M* in (mm)	N* in (mm)	P1** in (mm)	R in (mm)	S in (mm)
PT-8 TROLLEY DIMENSIONS								
PT005-8A	0.88" (22)	0.75" (19)	6" (154)	1.06" (27)	3.94" (100)	12.25" (311)	1.25" (32)	1.63" (41)
PT010-8A	0.88" (22)	1" (25)	6.88" (175)	1.45" (37)	4.2" (107)	12.87" (327)	1.5" (38)	1.63" (41)
PT020-8A	1.25" (32)	1.18" (30)	7.5" (191)	0.94" (24)	4.31" (110)	13.8" (335)	1.5" (38)	1.63" (41)
PT030-8A	1.25" (32)	1.43" (37)	8.5" (216)	1.62" (41)	5.38" (137)	14.12" (359)	2" (51)	2.56" (65)
PT050-8A	1.62" (41)	1.43" (37)	9.75" (248)	1.62" (41)	6.62" (168)	15.63" (397)	2.5" (64)	2.56" (65)

*Minimum dimension.

**Dimension for standard shaft length only.

Silver Series Lever Chain Hoists

3/4 to 6 Metric Ton Lifting Capacity

Meeting ANSI / ASME B30.16 and all pertinent world standards, the “-E” signifies compliance with Europe’s EC95 Machinery Directive.

The patent-pending, arrow-notch free-chain system is simple and reliable. Just one hand turns the indicator, and operators will enjoy the easiest free-chaining we have ever tested. Try to operate a Silver Series hoist in free-chain mode and the brake instantly engages, holding the load and minimizing the risk of an accident. Specify required lift in feet in the “L” position of model number.



Silver Series hoists have a zinc-nickel-chrome-plated finish. It’s more durable and corrosion-resistant than paint. Plus, the Silver Series has the quality features you expect from Ingersoll Rand.

- All-steel construction
- 360° handle rotation
- Rubber handle grip in all sizes
- Reliable disc brake
- Premium-grade alloy chain
- Hardened swivel-latch hooks
- Lightweight
- Low handle force
- Short handle stroke
- Standard lifts of 5, 10, 15, and 20 feet

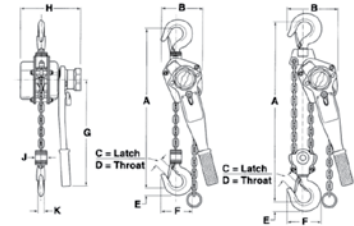

How to order

Specify required lift in feet in the “L” position of model number.

Example

SL150-15-EA = 3/4 ton, with 15 feet of lift.

Model	Rated Capacity		Pull to Lift Rated Load lb	No. of Chain Falls	A mm (in)	B mm (in)	C mm (in)	D mm (in)	E mm (in)	F (min) mm (in)	Ø mm (in)	Load Chain Size	
	Metric tons	(lb)										mm	(in)
SILVER SERIES CHAIN HOISTS													
SLB150	3/4	(1,650)	41	1	158 (6.2)	93 (3.6)	132 (5.2)	308 (12.1)	29 (1.1)	330 (13)	37 (1.5)	6 X 18	(0.24 x 0.71)
SLB200	1	(2,200)	60	1	163 (6.4)	95 (3.7)	140 (5.5)	308 (12.1)	32 (1.3)	365 (14.4)	40 (1.6)	6 X 18	(0.24 x 0.71)
SLB300	1-1/2	(3,300)	53	1	185 (7.3)	106 (4.2)	145 (5.7)	378 (14.9)	35 (1.4)	400 (15.7)	45 (1.8)	7.1 x 21.2	(0.28 x 0.84)
SLB600	3	(6,600)	53	1	212 (8.4)	118 (4.6)	199 (7.8)	418 (16.5)	44 (1.7)	520 (20.5)	55 (2.2)	10 x 30	(0.39 x 1.18)
SLB1200	6	(13,200)	57	2	212 (8.4)	118 (4.6)	230 (9.1)	418 (16.5)	50 (2)	640 (25.2)	65 (2.6)	10 x 30	(0.39 x 1.18)

SMB Manual Chain Hoists

Ingersoll Rand SMB Silver Series manual chain hoists offer the strength and durability you need in tough lifting situations. Their high-strength, all-stamped steel construction provides decreased weight and better impact resistance. In addition, the hoists feature roller bearings on input shafts and efficient gear reductions for easier lifting. Standard overload protection reduces downtime and repair costs resulting from abuse.

- Efficient gear reductions minimize hand chain overhauled to lift loads
- Encased and retained roller bearings for increased efficiency and ease of maintenance
- Single chain fall through 3 tons
- Nickel / chrome-plated exterior and zinc-plated frame components for increased corrosion resistance
- Double hand chain guides for smooth operation when pulling excess chain
- Open frame design for easy cleaning and inspection
- CE certified; hoists meet or exceed regional requirements including ASME B30.16, HST-2M
- Hardened swivel-latch hooks



Silver Series SMB manual chain hoists are ideal for these applications:

- Offshore drilling rigs
- Oil refineries and chemical plants
- Shipbuilding and shipyards
- Mining
- Utilities
- Steel mills and foundries
- General construction
- Maintenance and repairs
- Rigging

Model	Rated Capacity Metric Tons (lb)	No. of Chain Falls	Pull to Lift Rated Load lb	A in (mm)	B in (mm)	C in (mm)	D in (mm)	H (min) in (mm)	Load Chain Size in (mm)	Hoist Net Weight with 10' (3 m) Lift lb
SMB005	1/2 (1,100)	1	55	5.2" (131)	5.4" (137)	1.1" (29)	1.5" (37)	12.8" (325)	0.20" x 0.59" (5 X 15)	23.5
SMB010	1 (2,200)	1	64	5.9" (151)	6" (152.5)	1.3" (32)	1.6" (40)	13.8" (350)	0.24" x 0.71" (6 X 18)	26.8
SMB015	1-1/2 (3,300)	1	69	7" (177)	6.8" (173)	1.4" (35)	1.8" (45)	17.1" (435)	0.26" x 0.83" (7.1 x 21)	38.5
SMB020	2 (4,400)	1	77	7.6" (192)	6.9" (176)	1.6" (40)	2" (50)	18.2" (463)	0.31" x 0.94" (8 x 24.6)	42.4
SMB030	3 (6,600)	1	100	9.4" (238)	8.0" (204)	1.7" (44)	2.2" (55)	20.9" (530)	0.39" x 1.18" (10 x 30)	70.4
SMB050	5 (11,000)	1	83	11.2" (285)	7.4" (188)	2" (50)	2.6" (65)	28" (710)	0.35" x 1.06" (9 x 27.2)	90.2

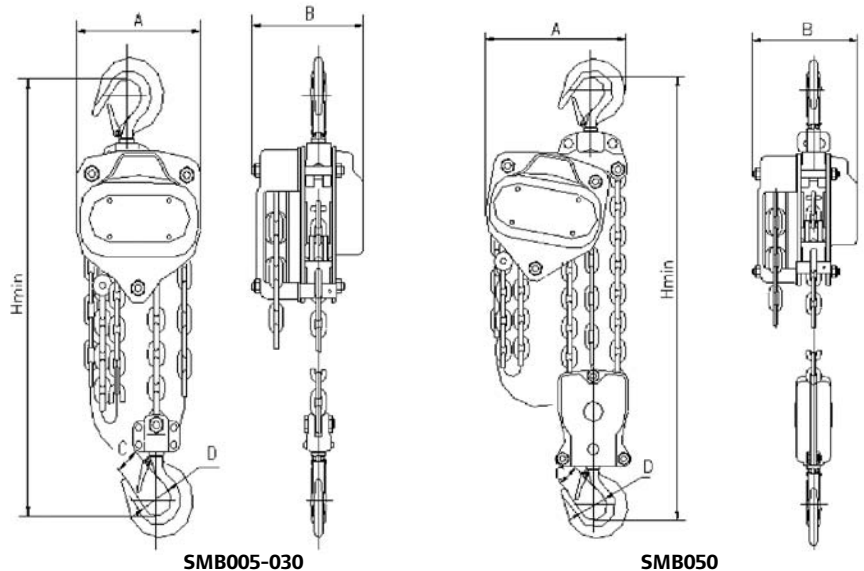

Index

Model Number	Description	Page
--------------	-------------	------

1

1033A	Air Ratchet Wrench, 3/8" Square Drive	43, 45
103A	Air Ratchet Wrench, 1/4" Square Drive	43, 45
104B	Air Ratchet Wrench, 1/4" Square Drive	43, 45
1077XPA	Air Ratchet Wrench, 1/2" Square Drive	44, 45
107XPA	Air Ratchet Wrench, 3/8" Square Drive	44, 45, 75
1099XPA	Air Ratchet Wrench, 1/2" Square Drive	44, 45
109XPA	Air Ratchet Wrench, 3/8" Square Drive	44, 45
1103	Air Ratchet Wrench, 1/4" Square Drive	43, 45
111	Air Ratchet Wrench, 3/8" Square Drive	44, 45
1111	Air Ratchet Wrench, 1/2" Square Drive	44, 45
1133	Air Ratchet Wrench, 3/8" Square Drive	43, 45
115	Air Hammer	64, 65
115-183	Spring Retainer	65
115K	Air Hammer	64
116	Air Hammer	64, 65
116K	Air Hammer	64
117	Air Hammer	64, 65
117K	Air Hammer	64
1200	Air Ratchet Wrench, 3/8" Square Drive	44, 45
121/Q	Air Hammer	64
1210	Air Ratchet Wrench, 1/2" Square Drive	44, 45
1215Ti	Air Ratchet Wrench, 1/4" Square Drive	43, 45
121-K6	Air Hammer Kit	64
1225Ti	Air Ratchet Wrench, 3/8" Square Drive	43
125	Needle Scaler	65
132	Air Hammer	64, 65
15TE15-FP	Two-Stage Air Compressor	92

2

2000	Electric Start-up Kit	94
2000 electric units	Maintenance Kit	95
2000E20-FP	Two-Stage Air Compressor	92
2000E25-FP	Two-Stage Air Compressor	92
2101K	Mini Tool Impactool Kit, 1/4"	7, 67
211	Air Impactool, 3/8" Square Drive	7, 14
2115QTi	Air Impactool, 3/8" Square Drive	7, 15, 16
2115Ti	Air Impactool, 3/8" Square Drive	7, 15, 16
212	Air Impactool, 3/8" Square Drive	7, 14, 16
2125QTi	Air Impactool, 1/2" Square Drive	9, 14, 15, 16
2130	Air Impactool, 1/2" Square Drive	9, 14, 15, 16
2130-2	Air Impactool, 1/2" Square Drive	9, 14, 15, 16
2135QTi-2MAX	Air Impactool, 1/2" Square Drive	10, 16
2135QTiMAX	Air Impact Wrench, 1/2" Square Drive	10, 16
2135Ti-2MAX	Air Impactool, 1/2" Square Drive	10, 16
2135TiMAX	Air Impact Wrench, 1/2" Square Drive	3, 10, 16
2141	Air Impactool, 3/4" Square Drive	11, 14, 15, 16
215	Air Impactool, 3/8" Square Drive	7, 14, 15, 16
216	Air Impactool, 3/8" Square Drive	7, 14, 15
2161XP	Air Impactool, 3/4" Square Drive	11, 14, 16
2161XP-6	Air Impactool, 3/4" Square Drive	11, 16
2171XP	Air Impactool, 1" Square Drive	13
2190DTi-6	Air Impactool, 1" Square Drive	13, 14
2190Ti	Air Impactool, 1" Square Drive	13, 14, 16
2190Ti-6	Air Impactool, 1" Square Drive	13, 14, 16

Model Number	Description	Page
--------------	-------------	------

231C	Air Impactool, 1/2" Square Drive	8, 14, 15, 16
231HA	Air Impactool, 1/2" Square Drive	8, 14, 15, 16
231HA-2	Air Impactool, 1/2" Square Drive	8, 14, 15, 16
232TGS	Air Impactool, 1/2" Square Drive	9, 16
2340	Electric Start-up Kit	94, 95
2340L5	Two-Stage Air Compressor	91
2340N5	Two-Stage Air Compressor	91
2340S9GH-AS	Gasoline-driven Air Sled Unit, Two-stage	89
236	Air Impactool, 1/2" Square Drive	8, 16
244A	Air Impactool, 1/2" Square Drive	8, 14, 16
244A-2	Air Impactool, 1/2" Square Drive	8, 14, 16
2475	Electric Start-up Kit	94, 95
247511.5GKA	Two-Stage Air Compressor	90
2475D5	Two-Stage Air Compressor	91
2475D5-FP	Two-Stage Air Compressor	92
2475F11.5GKA	Two-Stage Air Compressor	90, 94
2475F11GH	Gas Start-up Kit	94
2475F12.5G	Two-Stage Air Compressor	90, 94
2475F13GH	Two-Stage Air Compressor	90
2475N5	Two-Stage Air Compressor	91
2475N5-FP	Two-Stage Air Compressor	92
2475N7.5	Two-Stage Air Compressor	91
2475N7.5-FP	Two-Stage Air Compressor	92
252	Air Impactool, 3/4" Square Drive	11, 14
2545	Electric Start-up Kit	94, 95
2545E10-FP	Two-Stage Air Compressor	92
2545E10V	Two-Stage Air Compressor	91
2545E10VFP	Two-Stage Air Compressor	92
2545K10-FP	Two-Stage Air Compressor	92
2545K10V	Two-Stage Air Compressor	91
2545KVFP	Two-Stage Air Compressor	92
2545N7.5-PS	Electric Start-up Kit	94
258	Air Impactool, 3/4" Square Drive	11
261	Air Impactool, 3/4" Square Drive	11, 14, 15, 16
261-3	Air Impactool, 3/4" Square Drive	11, 16
261-6	Air Impactool, 3/4" Square Drive	11, 16
271	Air Impactool, 1" Square Drive	12, 16
280	Air Impactool, 1" Square Drive	12, 14, 16
280-6	Air Impactool, 1" Square Drive	12, 16
280-S-6	Air Impactool, #5 Spline Drive	12
285B	Air Impactool, 1" Square Drive	12, 15, 16
285B-6	Air Impactool, 1" Square Drive	12, 16
285B-S6	Air Impactool, #5 Spline Drive	12, 16
290	Air Impactool, 1" Square Drive	13, 14
290-S	Air Impactool, #5 Spline Drive	13
293	Air Impactool, 1" Square Drive	13, 16
293-S	Air Impactool, #5 Spline Drive	13, 16
295A	Air Impactool, 1" Square Drive	13, 16

3

301	Multi-purpose Air Angle Die Grinder	47, 48
301-2MK	Surface Conditioning Kit	48
301-32MK	Surface Conditioning Kit	48
301-3MK	Surface Conditioning Kit	48
301-K	Die Grinder Kit	48
302A	Air Angle Die Grinder	47

Index

Model Number	Description	Page
307A	Mini Air Die Grinder	47
307-K	Die Grinder Kit	48
308A	Air Die Grinder	47
3102	Composite Die Grinder	49, 75
3102K	Die Grinder Kit	48
3103K	Mini Surface Prep Grinder Kit	49, 67
3108	Composite Die Grinder	49, 75
310-825-6	Dual-action Backing Pads	58
3108K	Die Grinder Kit	48
311A	Dual-action Quiet Air Sander	51, 55
311A-825-6	Dual-action Backing Pads	58
3128K	Mini Random Orbital Sander Kit	55, 68
3129K	Mini Polisher Kit	55, 68
312A	Orbital Air Sander	54
313-825-7	Backing Pads	58
313A	Angle Air Sander	55
314A	Air Finishing Tool	55
315	Twin-piston Straight-line Air Sander	54
315-39	Straight Line Sanding Pad	58
317-825	Backing Pads	58
317A	High-speed Air Sander	54
318A	Vertical Air Polisher/Buffer	55
319A	Air Finishing Tool	55
325	Air Nibbler	50
326	Cut-off Tool	49
327	Air Finishing Tool	54
327LS	Low-speed Air Tire Buffer	54
328A-826	Dual-action Backing Pads	58
328B	Geared Orbital Air Sander	55
3445	Air Angle Grinder	49
354-69	Service Kit	58
371	Reversible Pistol-grip Screwdriver	61
38036281	Repair Kit	96
38334314	PacE Unit	96
38432613	Check Valve, 1/8" NPT	97
38432621	Transparent Polyurethane 1/4" Tubing	97
4		
4102K	Die Grinder Kit	48
4151	Vacuum-ready Random Orbital Air Sander	56, 57, 58
4151-2	Air Finishing Tool	56
4151-5	Air Finishing Tool	56
4151-HL	Air Finishing Tool	56
4151JV	Jet-Vac Conversion Kit	57, 58
4152	Vacuum-ready Random Orbital Air Sander	56, 57
4152-HL	Air Finishing Tool	56
429	Air Reciprocating Saw	50
4429	Air Cutting Tool	50
44548	Spanner Wrench	58
48266-1	Shroud	58
48878	Shroud	58
49094-1	Non-vacuum Pads, 3/8"	58
49096-1	Vacuum Pads, 3/8"	58
49099-1	Vacuum Pads, 3/8"	58
49694	Vacuum Pads, 3/8"	58
49802	Port Adapter	58
49877-1	Non-vacuum Pads, 3/8"	58

Model Number	Description	Page
49879-1	Non-vacuum Pads, 3/8"	58
49880-1	Non-vacuum Pads, 3/8"	58
49987	Disposable Vacuum Bags (250 pack)	57, 58
49988	Disposable Vacuum Bags (20 pack)	57, 58
49997	Bag Cover	57, 58
5		
5190	Hand-held Grease Gun	120
550	Hand-held Grease Gun	120
570	Hand-held Grease Gun	120
590	Hand-held Grease Gun	120
6		
60798	Non-drip Nozzle	118
611016	Lubrication Pump	122
611170	Motor Oil, Gear Oil, Transmission Fluid, 5-gal	122
612041-1	Series 200 Piston Pump	111
612041-3	Series 200 Piston Pump	111
612042-1	Series 200 Piston Pump	111
6120A	Dual-action Backing Pads	58
6121A	Dual-action Backing Pads	58
6122A	Dual-action Backing Pads	58
6123A	Dual-action Backing Pads	58
612999-24	Fresh Oil Caddy	122
612999-3	Specialty Application Pump	113
612999-4	Specialty Application Pump	113
612999-5	Specialty Application Pump	113
612999-6	Specialty Application Pump	113
6130A	Backing Pads	58
613201-2-C	Specialty Application Pump	113
6135A	Polishing Pad	58
62131	Self-evacuating Oil Caddy	121
621603-6	Connection Kit	121
629212	Non-drip Nozzle/Hose	118
629226	Non-drip Nozzle/Hose	118
629245-1	Flexhose, Non-drip Tip	118
629245-2	Rigid Tube, Non-drip Tip	118
629516	Non-drip Nozzle/Hose	118
629521	Right-angle Nozzle/Hose	118
629742	Whip Hose for Grease Control Handles	119
6332	Low-pressure Hose Reel	116
6338	Low-pressure Hose Reel	116
635129	Radiator Bib	117, 119
635190-1	Fluid Control Handle, Meter Only	117
635190-2	Fluid Control Handle, Meter Only	117
635190-3	Fluid Control Handle, Meter Only	117
635193	Non-metered Fluid Control Handle	117
635360-2	Metered Fluid Control Handle	118
635360-22	Metered Fluid Control Handle	118
635360-3	Metered Fluid Control Handle	118
635360-33	Metered Fluid Control Handle	118
635364	Metered Fluid Control Handle	118
635365	Metered Fluid Control Handle	118
635367	Metered Fluid Control Handle	118
635390-1	Metered Fluid Control Handle	117
635390-10	Metered Fluid Control Handle	117

Index

Model Number	Description	Page
635390-11	Metered Fluid Control Handle	117
635390-2	Metered Fluid Control Handle	117
635390-20	Metered Fluid Control Handle	117
635390-22	Metered Fluid Control Handle	117
635390-3	Metered Fluid Control Handle	117
635390-30	Metered Fluid Control Handle	117
635390-33	Metered Fluid Control Handle	117
635391-1	Non-metered Fluid Control Handle	117
635391-11	Non-metered Fluid Control Handle	117
635392	Non-metered Fluid Control Handle	117
635395-2	Non-metered Fluid Control Handle	117
635399	Non-metered Fluid Control Handle	117
6358	Low-pressure Hose Reel	116
6358G	Green Hose Reel, 50 Ft. 3/8"	116
636101	High-pressure Grease Control Handle	119
636103	High-pressure Grease Control Handle	110, 119
636111	High-pressure Grease Control Handle	110, 119
650715-C	Specialty Application Pump	113
650717-C	Diaphragm Pump	113
650718-C	Diaphragm Pump	113
650719-C	Diaphragm Pump	113
662409	Series 425 Piston Pump	111
662410-B	Series 425 Piston Pump	111
662420-B	Series 425 Piston Pump	111
66605J-322	Diaphragm Pump	112, 113
66605J-344	Diaphragm Pump	112
66605J-388	Diaphragm Pump	112, 113
666100-322-C	Diaphragm Pump	113
666100-344-C	Diaphragm Pump	113
666100-362-C	Diaphragm Pump	113
666100-3C9-C	Diaphragm Pump	113
666150-362-C	Diaphragm Pump	113
666250-9C9-C	Diaphragm Pump	113
67384	Self-evacuating Oil Caddy	121
6786	Non-drip Nozzle	118
7		
7001	OH Mounting Bracket	116
7002	Wall-mount Swing Bracket	116
7003	Floor-mount Swivel Bracket	116
7004	Ceiling-mount Bracket	116
7005	I or H Beam Adapter	116
7006	Wall-mount Swing Bracket	116
7007	Reelcraft Adapter Bracket	116
7008	Graco Adapter Plate	116
7009	OH Mounting Bracket	116
7100	Electric Start-up Kit	94, 95
7100E10-PS	Electric Start-up Kit	94
7100E15	Two-Stage Air Compressor	91
7100E15-FP	Two-Stage Air Compressor	92
728-99-KC5	Chuck Key	62
728-99-KC8	Chuck Key	62
7802-99	Chuck Key	62
7802A	Air Drill	60, 62
7802RA	Reversible Air Drill	60, 62
7802RAKC	Reversible Air Drill/Keyless Chuck	60, 62
7802SA	Air Shear	50

Model Number	Description	Page
7803-99	Chuck Key	62
7803A	Air Drill	60, 62
7803RA	Air Drill	60, 62
7803RAKC	Air Drill	60, 62
7804K	Mini Drill/Driver Kit, 1/4"	61, 67
7807R	Angle Reversible Drill, 3/8"	61
7E16050A-SR	Electric Cord	115
7E16050D-SR	Electric Cord	115
7SH1110-SR	Supreme-duty Hose Reel	115
7SL3050-SR	Supreme-duty Hose Reel	115
7SL3075-SR	Supreme-duty Hose Reel	115
7SL4050-SR	Supreme-duty Hose Reel	115
7SL4075-SR	Supreme-duty Hose Reel	115
7SM4050-SR	Supreme-duty Hose Reel	115
7UH3025	Ultra-duty Hose Reel	114
7UH3025-SR	Ultra-duty Hose Reel	114
7UH3050	Ultra-duty Hose Reel	114
7UH3050-SR	Ultra-duty Hose Reel	114
7UL3035	Ultra-duty Hose Reel	114
7UL3050	Ultra-duty Hose Reel	114
7UL3050-SR	Ultra-duty Hose Reel	114
7UL4030	Ultra-duty Hose Reel	114
7UL4050	Ultra-duty Hose Reel	114
7UL4050-SR	Ultra-duty Hose Reel	114
7UM4025	Ultra-duty Hose Reel	114
7UM4025-SR	Ultra-duty Hose Reel	114
7UM4050	Ultra-duty Hose Reel	114
7UM4050-SR	Ultra-duty Hose Reel	114
8		
8049 Model C	Electric Impacttool	9
9		
9500	5-piece Hammer Chisel Set	64, 65
950011	Tailpipe Cut-off Tool	65
950012	Slotted Panel Cutter	65
950013	Rivet and Bolt Cutter	65
950014	Pneumatic Scraper	65
950015	Pneumatic Hammer Chisel	65
950016	Pneumatic Cold Chisel, 8"	65
950017	Pneumatic Cold Chisel	65
950018	Muffler and Tailpipe Remover	65
950019	Pneumatic Ball Joint Separator	65
9505	Hammer Spring Retainer, 2 pack	65
9510	Quick Change Hammer Retainer	65
96268	Transmission Funnel	121
96269	Tool Tray	121
96548	Transmission Funnel	121
A		
AVC10-183A	Spring Retainer	65
AVC1-83	Beehive Retainer	65

Index

Model Number	Description	Page
C		
C400HA	C-Series Puller	134
C400SA	C-Series Puller	134
D		
D040	Mini Drill, 1/4"	74, 81
D550	Cordless Drill/Driver	74, 81
D650	Cordless Drill/Driver	74, 81
DD2T2	Single-stage Air Compressor	88
D12IN	Refrigerated Dryer	93
D18IN	Refrigerated Dryer	93
D25IN	Refrigerated Dryer	93
D42IN	Refrigerated Dryer	93
D54IN	Refrigerated Dryer	93
D72IN	Refrigerated Dryer	93
D108IN	Refrigerated Dryer	93
D144IN	Refrigerated Dryer	93
D180IN	Refrigerated Dryer	93
D300IN	Refrigerated Dryer	93
D360IN	Refrigerated Dryer	93
F		
F01-02-000	Inline Filter	105
F35IG	General Purpose Inline Air Filter	99
F35IH	High-efficiency Inline Air Filter	99
F71IG	General Purpose Inline Air Filter	99
F71IH	High-efficiency Inline Air Filter	99
F108IG	General Purpose Inline Air Filter	99
F108IH	High-efficiency Inline Air Filter	99
F144IG	General Purpose Inline Air Filter	99
F144IH	High-efficiency Inline Air Filter	99
F178IG	General Purpose Inline Air Filter	99
F178IH	High-efficiency Inline Air Filter	99
F212IG	General Purpose Inline Air Filter	99
F212IH	High-efficiency Inline Air Filter	99
F395IG	General Purpose Inline Air Filter	99
F395IH	High-efficiency Inline Air Filter	99
F424IG	General Purpose Inline Air Filter	99
F424IH	High-efficiency Inline Air Filter	99
G		
GC25	Cut-off Tool	76
GP123	General Purpose Inline Air Filter	99
GP19	General Purpose Inline Air Filter	99
GP216	General Purpose Inline Air Filter	99
GP40	General Purpose Inline Air Filter	99
GP64	General Purpose Inline Air Filter	99
GR25	Cordless Angle Grinder	75
GS25	Cordless Straight Grinder	75
H		
HE123	High-efficiency Inline Air Filter	99
HE19	High-efficiency Inline Air Filter	99
HE216	High-efficiency Inline Air Filter	99

Model Number	Description	Page
HE40	High-efficiency Inline Air Filter	99
HE64	High-efficiency Inline Air Filter	99
L		
LM2203A-11-C	LM Series Piston Pump	109
LM2203A-31-C	LM Series Piston Pump	109
LM2203A-41-C	LM Series Piston Pump	109
LM2203A-51-C	LM Series Piston Pump	109
LM2250E-21-B	LM Series Piston Pump	109
LM2250E-31-B	LM Series Piston Pump	109
LM2250E-41-B	LM Series Piston Pump	109
LM2250E-61-B	LM Series Piston Pump	109
LM2305A-11-B	LM Series Piston Pump	109
LM2305A-41-B	LM Series Piston Pump	109
LM2305A-51-B	LM Series Piston Pump	109
LM2350E-21-B	LM Series Piston Pump	109
LM2350E-31-B	LM Series Piston Pump	109
LP2001-1-B	LP Series Piston Pump	110
LP2002-1-B	LP Series Piston Pump	110
LP2003-1-B	LP Series Piston Pump	110
LP2004-1-B	LP Series Piston Pump	110
LP2006-1-B	LP Series Piston Pump	110
LP2100-1-B	LP Series Piston Pump	110
LP3001-1	LP Series Piston Pump	110
LP3002-1	LP Series Piston Pump	110
LP3003-1	LP Series Piston Pump	110
LP3004-1	LP Series Piston Pump	110
LP3005-1	LP Series Piston Pump	110
LP3007-1	LP Series Piston Pump	110
LP3100-1-B	LP Series Piston Pump	110
P		
P15D3HA	P-Series Puller	134
P15HA	P-Series Puller	134
PD03P-AES-DCC	Diaphragm Pump	112
PD03P-AES-DTT	Diaphragm Pump	112
PD03P-ARS-PCC	Diaphragm Pump	112
PD03P-ARS-PTT	Diaphragm Pump	112
PD05P-AES-DCC-B	Diaphragm Pump	112
PD05P-AES-DTT-B	Diaphragm Pump	112
PD05P-ARS-PAA-B	Diaphragm Pump	112
PD05P-ARS-PCC-B	Diaphragm Pump	112
PD05P-ARS-PTT-B	Diaphragm Pump	112
PF2200-3231	Round Nose Chisel	65
PF2200-3232	Cape Chisel	65
PF2200-390	Scraper	65
PF2200-390-3	Scraper	65
PF2200-391	Chisel	65
PF2200-392	Chisel	65
PF2200-393	Wide Chisel	65
PF2200-394	Angle Chisel	65
PPT005-8A	Trolley Hanger Shaft, 8'	135
PS-030	PolySep Condensate System	98
PS-060	PolySep Condensate System	98
PS-125	PolySep Condensate System	98
PT005-8A	Trolley	135

Index

Model Number	Description	Page
PT010-8A	Trolley Hanger Shaft, 8'	135
PT020-8A	Trolley Hanger Shaft, 8'	135
PT030-8A	Trolley Hanger Shaft, 8'	135
PT050-8A	Trolley Hanger Shaft, 8'	135

R

R140	1/4" Cordless Mini Ratchet	45, 75
R145	3/8" Cordless Mini Ratchet	75
R380	3/8" Cordless Standard Ratchet	45, 75
R385	1/2" Cordless Standard Ratchet	75

S

SLB1200	Silver Series Lever Chain Hoist	136
SLB150	Silver Series Lever Chain Hoist	136
SLB200	Silver Series Lever Chain Hoist	136
SLB300	Silver Series Lever Chain Hoist	136
SLB600	Silver Series Lever Chain Hoist	136
SMB005	SMB Manual Chain Hoist	137
SMB010	SMB Manual Chain Hoist	137
SMB015	SMB Manual Chain Hoist	137
SMB020	SMB Manual Chain Hoist	137
SMB030	SMB Manual Chain Hoist	137
SMB050	SMB Manual Chain Hoist	137
SS3	Electric Start-up Kit	94
SS3 electric units	Maintenance Kit	95
SS3F2-GM	Single-stage Air Compressor	88
SS3J2-WB	Single-stage Air Compressor	89
SS3J3-AS	Single-stage Air Compressor	89
SS3J3-WB	Single-stage Air Compressor	89
SS3J5.5GB-WB	Single-stage Air Compressor	89, 94
SS3J5.5GH-AS	Single-stage Air Compressor	89, 94
SS3J5.5GH-WB	Single-stage Air Compressor	89, 94
SS3L3	Single-stage Air Compressor	90
SS3R2-GM	Single-stage Air Compressor	88
SS5	Electric Start-up Kit	94
SS5 electric units	Maintenance Kit	95
SS5L5	Single-stage Air Compressor	90

T

TL10	Task Light	76
TS7F11.5GKA	Gas Start-up Kit	94
TS7F12.5G	Gas Start-up Kit	94
TS7F13GHG	Gas Start-up Kit	94

U

UP6-10-125	Rotary Screw Air Compressor	84
UP6-10-150	Rotary Screw Air Compressor	84
UP6-10TAS-125	Rotary Screw Air Compressor	85
UP6-10TAS-150	Rotary Screw Air Compressor	85
UP6-15c-125	Rotary Screw Air Compressor	84
UP6-15c-150	Rotary Screw Air Compressor	84
UP6-15cTAS-125	Rotary Screw Air Compressor	85
UP6-15cTAS-150	Rotary Screw Air Compressor	85
UP6-20-125	Rotary Screw Air Compressor	86

Model Number	Description	Page
UP6-20-125	w/ Integrated Dryer.. Rotary Screw Air Compressor	87
UP6-20-150	Rotary Screw Air Compressor	86
UP6-20-150	w/ Integrated Dryer.. Rotary Screw Air Compressor	87
UP6-25-125	Rotary Screw Air Compressor	86
UP6-25-125	w/ Integrated Dryer.. Rotary Screw Air Compressor	87
UP6-25-150	Rotary Screw Air Compressor	86
UP6-25-150	w/ Integrated Dryer.. Rotary Screw Air Compressor	87
UP6-30-125	Rotary Screw Air Compressor	86
UP6-30-125	w/ Integrated Dryer.. Rotary Screw Air Compressor	87
UP6-30-150	Rotary Screw Air Compressor	86
UP6-30-150	w/ Integrated Dryer.. Rotary Screw Air Compressor	87
UP6-40-115	Rotary Screw Air Compressor	86
UP6-40-115	w/ Integrated Dryer.. Rotary Screw Air Compressor	87
UP6-40-125	Rotary Screw Air Compressor	86
UP6-40-125	w/ Integrated Dryer.. Rotary Screw Air Compressor	87
UP6-40-150	Rotary Screw Air Compressor	86
UP6-40-150	w/ Integrated Dryer.. Rotary Screw Air Compressor	87
UP6-5-125	Rotary Screw Air Compressor	84
UP6-5-150	Rotary Screw Air Compressor	84
UP6-5TAS-125	Rotary Screw Air Compressor	85
UP6-5TAS-150	Rotary Screw Air Compressor	85
UP6-7.5-125	Rotary Screw Air Compressor	84
UP6-7.5-150	Rotary Screw Air Compressor	84
UP6-7.5TAS-125	Rotary Screw Air Compressor	85
UP6-7.5TAS-150	Rotary Screw Air Compressor	85

W

W040	QC Cordless Impactool, 1/4"	72, 73, 81
W040-LSP	QC Impactool 7.2-volt Lithium-ion Starter Pack, 1/4"	73
W040-NSP	QC Impactool 7.2-volt Nickel-cadmium Starter Pack, 1/4"	73
W040P	Cordless Impactool	72
W040SQ	Cordless Impactool	72
W150	Cordless Impactool, 3/8"	72, 73, 81
W150-LSP	Impactool 14.4-volt Lithium-ion Starter Pack, 3/8"	73
W150-NSP	Impactool 14.4-volt Nickel-cadmium Starter Pack, 3/8"	73
W150P	Cordless Impactool	72
W150QC	Cordless Impactool	72
W175	Cordless Impactool	72
W175P	Cordless Impactool	72
W360	Cordless Impactool, 1/2"	72, 73, 81
W360-2	Cordless Impactool	72
W360-LSP	Impactool 19.2-volt Lithium-ion Starter Pack, 1/2"	73
W360-NSP	Impactool 19.2-volt Nickel-cadmium Starter Pack, 1/2"	73
W360P	Cordless Impactool	72

Index

Model Number	Description	Page	Model Number	Description	Page
---------------------	--------------------	-------------	---------------------	--------------------	-------------

Why certified service?

- Genuine parts and lubricants
- Factory certified technicians
- Tested to OEM specifications
- Factory repair warranty

... Peace of mind!

For service and repair visit, us at
irtools.com/locator

United States

Ingersoll Rand
Tel: +1-800-TOOLHLP
Fax: +1-615-672-7678

Canada

Ingersoll Rand Canada
Tel: +1-800-TOOLHLP
Fax: +1-416-213-4510

Mexico

Ingersoll Rand S.A. de C.V.
Tel: +52 55 5005-6600
Fax: +52 55 5565-3072

Chile

Ingersoll Rand Chile
Tel: +56 2 444-6800
Fax: +56 2 485-8303

Brazil

Ingersoll Rand do Brasil Ltda
Tel: +55 11 2109-8900
Fax: +55 11 2109-8998

UK and Ireland

Ingersoll Rand Sales Co. Ltd.
Tel: +44 1942 500030
Fax: +44 1942 503451

France

Ingersoll Rand
Tel: +33 8 10 22 27 77
Fax: +33 1 30 07 69 80

Spain and Portugal

Ingersoll Rand Iberica
Tel: +34 91 6277405
Fax: +34 91 6277406

Italy

Ingersoll Rand Italiana Spa
Tel: +39 (0) 2 950561
Fax: +39 (0) 2 95360159

Korea

Ingersoll Rand Korea
Tel: +82-2-3660-6800
Fax: +82-2-3141-8010

Singapore

Ingersoll Rand South East Asia (Pte) Ltd.
Tel: +65-6860-6800
Fax: +65-6862-1373

Germany, Austria, and Switzerland

Ingersoll Rand GmbH
Tel: +49 208 999 4422
Fax: +49 208 999 4444

Scandinavia

Ingersoll Rand
Tel: +47 2255 1526
Fax: +47 2243 6581

Russia and CIS

Ingersoll Rand
Tel: +7 495 933 03 24
Fax: +7 495 785 21 26

Czech Republic and Slovakia

Ingersoll Rand
Tel: +420 2 57 109 756
Fax: +420 2 57 109 758

China

Shanghai Service Center
Tel: +86-21-5691-1778
Fax: +86-21-5691-1779

Australia

Ingersoll Rand (Australia) Ltd.
Tel: +61-3-8787-4300
Fax: +61-3-8787-5510

Belgium, Netherlands, and Luxembourg

Ingersoll Rand
Tel: +33 8 10 22 27 77
Fax: +33 1 30 07 69 80

Greece

Ingersoll Rand
Tel: +33 1 30 07 69 60
Fax: +33 1 30 07 69 80

Poland

Ingersoll Rand
Tel: +48 22 635 72 45
Fax: +48 22 635 73 32

Hungary, Slovenia, and Croatia

Ingersoll Rand
Tel: +36 28 512 800
Fax: +44 1942 520319

Malaysia

Ingersoll Rand Malaysia Co. Sdn.Bhd.
Tel: +60-3-5633-3322
Fax: +60-3-5634-5911

Japan

Ingersoll Rand Japan, Ltd.
Tel: +81-3-5420-3392
Fax: +81-3-5420-9116

Bulgaria, Romania, and Serbia and Montenegro

Ingersoll Rand
Tel: +359 2 961 79 65
Fax: +359 2 961 79 69

Estonia, Latvia, and Lithuania

Ingersoll Rand
Tel: +372 653 0110
Fax: +372 653 0112

Sub-Saharan Africa

Ingersoll Rand
Tel: +27 11 864 3930
Fax: +27 11 864 3954

Middle East and Northern Africa

Ingersoll Rand
Tel: +971 (0) 43313984
Fax: +971 (0) 43313032

India

Ingersoll Rand Wadco Tools Pvt. Limited
Tel: +91-120-4389200
Fax: +91-120-4389444

Distributed by:



Ingersoll Rand Industrial Technologies provides products, services and solutions that enhance our customers' energy efficiency, productivity and operations. Our diverse and innovative products range from complete compressed air systems, tools and pumps to material and fluid handling systems and environmentally friendly microturbines. We also enhance productivity through solutions created by Club Car®, the global leader in golf and utility vehicles for businesses and individuals.

(800) 376-TOOL • irtools.com